

# LETHAL IN DISGUISE 2

---

How Crowd-Control Weapons Impact  
Health and Human Rights



This report is a joint project of the International Network of Civil Liberties Organizations (INCLO) and Physicians for Human Rights (PHR) in collaboration with the Omega Research Foundation (Omega).

## ABOUT INCLO

The International Network of Civil Liberties Organizations (INCLO) comprises 15 independent national human rights organizations working to promote fundamental rights and freedoms by supporting and mutually reinforcing the work of member organizations working in their respective countries and collaborating on bilateral and multilateral bases. Each organization is multi-issue, multi-constituency, domestic in focus and independent of government, and advocates on behalf of all people in its country through litigation, legislative campaigning, public education, and grassroots advocacy.

The members of INCLO are Agora International Human Rights Group (Agora) in Russia; the American Civil Liberties Union (ACLU) in the USA; the Association for Civil Rights in Israel (ACRI); the Canadian Civil Liberties Association (CCLA); Centro de Estudios Legales y Sociales (CELS) in Argentina; the Commission for the Disappeared and Victims of Violence (KontraS) in Indonesia; Dejusticia in Colombia; the Egyptian Initiative for Personal Rights (EIPR); the Human Rights Law Centre (HRLC) in Australia; the Human Rights Law Network (HRLN) in India; the Hungarian Civil Liberties Union (HCLU); the Irish Council for Civil Liberties (ICCL); the

Kenya Human Rights Commission (KHRC); the Legal Resources Centre (LRC) in South Africa; and Liberty in the United Kingdom.

Police brutality, discrimination, and protest rights are priority areas for INCLO. INCLO members partner to advocate against government and police repression of protests and to promote human rights activism. INCLO also seeks to promote and protect the right to protest by combining technical work—the compilation of standards and analysis—with creating materials intended for a wider audience. Previous reports include: *Take Back the Streets: Repression and Criminalization of Protest Around the World* (2013); *Defending Dissent: Towards State Practices That Protect and Promote the Right to Protest* (2018), in partnership with The Global Human Rights Clinic of the University of Chicago Law School; and *Protesting During a Pandemic: State Responses During COVID-19* (2021).

The INCLO members that participated in this report are the ACLU, ACRI, Agora, CCLA, CELS, KontraS, Dejusticia, HCLU, HRLC, HRLN, ICCL, KHRC and the LRC. Liberty is not an author or party to the report.

For more information, visit [inclo.net](http://inclo.net).



## ABOUT PHR

For nearly 30 years, Physicians for Human Rights (PHR) has used science and medicine to document and call attention to mass atrocities and other severe human rights violations. PHR is a global organization founded on the idea that health professionals, with their specialized skills, ethical duties and credible voices, are uniquely positioned to stop human rights violations.

PHR's investigations and expertise are used to advocate for the protection of persecuted health workers, prevent torture, document mass atrocities and hold those who violate human rights accountable. In 1999, PHR led the effort to develop the internationally recognized *Manual on the Effective Investigation and Documentation of Torture and Other Cruel, Inhuman or Degrading Treatment or Punishment*, also known as the Istanbul Protocol, which PHR was instrumental in updating in 2022. PHR has a long history of advocating against weapons that can cause grave injury to civilian populations including organizing against the use of landmines for which PHR shared

the Nobel Prize in 1997. As to crowd-control weapons in particular, PHR has assessed the adverse health effects in a number of places, including Bahrain, Egypt, the Occupied Palestinian Territory (OPT), the Republic of Korea (South Korea), Thailand and Türkiye. PHR's studies have documented severe injuries due to birdshot and rubber bullets in Panama and the OPT, abuse of tear gas posing risks to health in Bahrain, South Korea and Turkey, as well as beatings using batons and sticks.

Through direct examination of victims, desk research and scientific evaluation of weaponry and its potential adverse consequences (when used both appropriately and inappropriately), PHR has brought relevant information to advocates and policymakers seeking to curtail responses by police and security forces that not only suppress lawful dissent, but also harm human health.

For more information, visit [phr.org](http://phr.org).



## ABOUT OMEGA

Founded in 1990, the Omega Research Foundation (Omega) is a UK-based nongovernmental research organisation. Omega investigates and exposes the global manufacture, trade, procurement, and use of a wide range of military, security, and policing weapons, including small arms and light weapons as well as large weapon systems, surveillance technologies, vehicles, and a wide range of law enforcement equipment. Omega works to ensure that human rights and international humanitarian law violations, including torture and other ill-treatment, are not committed or facilitated by people using such equipment and techniques, so that people are free to exercise their full range of human rights without the threat of violence and repression.

Omega's years of specialist research and investigation have generated an unrivalled source of evidence on equipment used for torture and repression. Using this data, Omega seeks to end the manufacture, trade, and use of inherently abusive weapons, such

as batons with metal spikes, which have no lawful use. Omega also strives to strengthen controls on other weapons that are frequently used for repression and human rights violations, including torture and ill-treatment, such as batons, handcuffs, and tear gas. Omega looks to increase transparency and improve controls on the trade of military, security, and policing equipment worldwide.

Omega is working to strengthen use of force standards and their application, support human rights monitors and researchers around the world, force governments to change laws, campaign to control the trade in weapons and equipment, hold corporations and individuals to account, and secure justice for survivors of torture.

For more information, visit [omegaresearchfoundation.org](http://omegaresearchfoundation.org).



---

## ACKNOWLEDGEMENTS

The report was written by **Rohini J. Haar**, MD, MPH, Medical Advisor, Physicians for Human Rights, Assistant Adjunct Professor, Division of Epidemiology, School of Public Health and Research Fellow, Human Rights Center, University of California, Berkeley, and Emergency Physician, Kaiser Medical Center, Oakland and **Scott Reynhout**, PhD, Researcher for Physicians for Human Rights (PHR). Section 3 on the laws on the use

of force and crowd-control weapons was written by **Michael Power**, Attorney of the High Court of South Africa, Director and Co-founder of ALT Advisory, and consultant for Protest Rights and Policing, INCLO.

This report is based on research conducted by **Rohini J. Haar**, **Scott Reynhout**, and **James Smith**, MBBS, with support from **Sunsaara Shergill** and **Arthi Inagandla**. **Tara**

**Davis** and **Wendy Trott** assisted **Michael Power** with the preparation of Section 3.

The primary contributors and editors of the report were **Sherylle Dass** (Regional Director, LRC), **Sofia Forero Alba** (Researcher, Dejusticia), **Laura Kauer Garcia** (Protest Rights and Policing Project Manager, INCLO), **Martin Mavunjina** (Senior Program Advisor, KHRC), **Luciana Pol** (Senior Fellow, Security Policy and Human Rights, CELS), **Michael Power** (Director, ALT Advisory), **Lucila Santos** (Program Director, INCLO), **Anne Suciu** (Attorney, ACRI), and **Jennifer Turner** (Human Rights Researcher, ACLU). The main working group met for an editing meeting in Bogota, Colombia, on 9-11 May 2022. We are grateful to the Dejusticia staff that welcomed and hosted us.

Other INCLO members contributed to the drafting of case studies and reviewing the executive summary and recommendations, including **Jamil Dakwar** (ACLU), **Kirill Koroteev** (Agora), **Abby Deshman** (CCLA), **Juliana Miranda** (CELS), **Sehba Menai** (HRLN), **Alice Drury** (HRLC), **Szabolcs Hegyi** (HCLU), **Doireann Ansbro** (ICCL), **Auliya Rayyan**, **Nadine Sherani** and **Rozy Brilian Dosik** (KontraS), and **Devon Turner** (LRC).

The **Omega Research Foundation** contributed with research on the trade and manufacture for the Colombia and South Africa case studies, as well as with drafting and reviewing of the recommendations. We

are particularly grateful to **Rebecca Shaw** for her contributions to drafting, reviewing, and preparing for the launch of this report.

Representatives of PHR who reviewed and edited this report include **Michele Heisler**, MD, MPA, **David Berry**, **Kevin Short**, **Karen Naimer**, JD, LL.M., **Erika Dailey**, MA, **Michael Payne**, **Gerson H. Smoger**, JD, PhD, and **Christian DeVos**, JD, PhD. This report also was reviewed by two content experts who are part of PHR's Advisory Council, **Vincent Iacopino** MD, PhD, and **Howard Hu** MD, MPH, ScD.

INCLO and PHR thank **Taryn McKay** for the design of this report and its accompanying webbased platform ([lethalindisguise.org](http://lethalindisguise.org)), **Tali Mayer** for photo editing, **Kale Vandebroek** and **Oleh Kolisny** for illustrations, and **ALT Advisory** for copyediting. We also thank **Myriam Selhi** for her support in the design of the report, sourcing photos, reviewing copy for the website, and communications materials.

INCLO is grateful to the **Wellspring Philanthropic Fund**, the **Ford Foundation**, the **Oak Foundation**, the **Open Society Foundation** and the **Bertha Foundation** for their generous support of its work in this area. PHR expresses its gratitude to the **Piper Fund**, an initiative of the **Proteus Fund**, which funded this research.



# CONTENTS

ACKNOWLEDGEMENTS .....4  
EXECUTIVE SUMMARY .....8  
    Summary of findings .....10  
    Summary of recommendations .....14

Section 1

INTRODUCTION.....19  
    Methodology and limitations .....21  
    Trends and context of recent protests and movements .....23  
    History and culture of policing .....25

Section 2

CROWD-CONTROL WEAPONS AND THEIR IMPACTS .....26

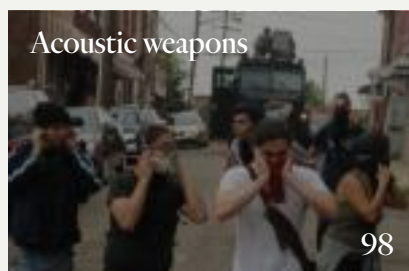



Section 3

**LAWS AND STANDARDS ON THE USE OF FORCE AND CROWD-CONTROL WEAPONS** .....123

- International human rights law ..... 124
- International standards and best practices .....132
- Regional and national standards and best practices ..... 142
- Implementation of the law: experiences from the field .....144



Section 4

**NEW AND REVISED RECOMMENDATIONS AND THE WAY FORWARD**..... 151

- Observations ..... 151
- Recommendations .....154
  - Pre-deployment of CCWs .....154
  - Use of force and deployment of CCWs .....159
  - Post-deployment of CCWs and medical assistance .....164
- Next steps .....165
- Final remarks .....168

**USEFUL RESOURCES** .....169

## EXECUTIVE SUMMARY

Public protests have surged across the world in recent years, often led by grassroots movements seeking to challenge social and economic injustices, express discontent and demand transformative change from their governments. Economic inequity led to the 2018 “Yellow Vests” protests in France, and echoes of these protests were felt in the 2019 Chile protests, the 2020 Indian farmers’ protests, and those across Colombia in 2021. George Floyd’s 2020 murder by a policeman set off a historic wave of protests across the United States and globally, while similar cases of police brutality were behind the #EndSARS protests in Nigeria.

Protests against authoritarian governments were also seen in places such as Hong Kong in 2019, in Myanmar, Israel and the Occupied Palestinian Territories in 2021, and more recently in Iran, Russia and China in 2022. Recent demonstrations have also played out against the backdrop of the COVID-19 pandemic, in which global protests have occurred in response to perceived government ineptitude or overreach. Whether this pattern of ongoing protests represents a momentary period of turbulence or a new normal is yet to be seen. What is clear is that people-driven protest movements are becoming an increasingly common aspect of the 21<sup>st</sup>-century geopolitical landscape.

Law enforcement and security forces have frequently responded to these protests with excessive force and violence that

fundamentally undermine the rights to free expression and assembly. The unnecessary and disproportionate use of force often serves not to disperse crowds and quell dissent but rather leads to acrimony and further escalation of conflict. Such uses of force often involve crowd-control weapons (CCWs), weapons ostensibly designed to inflict sublethal pain on individuals.<sup>1</sup> The rising popularity of CCWs by state actors highlights alarming trends in policing across the world: growing authoritarianism, the militarization of law enforcement, unregulated and precipitous use of weapons against peaceful, unarmed people, politically biased decisions to use force, little transparency around when, how and why CCWs are used and no meaningful accountability. The result is thousands of people worldwide who have been seriously injured or killed by these weapons, and the chilling effect of this violence on millions more.

Rigorous documentation of injuries resulting from the use of CCWs is necessary for understanding their impacts both on health and on assembly, association and free expression rights. In 2016, the International Network of Civil Liberties Organizations (INCLEO) and Physicians for Human Rights (PHR) published *Lethal in Disguise* (LiD1), which was the first report to systematically catalogue the health risks and consequences of CCWs. Our 2016 report leveraged an extensive review of the peer-reviewed medical literature, augmented by reviews

---

<sup>1</sup> It is important to note that the violent repression of protesters is not always or solely supported by the use of CCWs. In many countries, including where INCLEO member organizations are based (e.g. the United Kingdom), tear gas, water cannons and other CCWs discussed in this report are not used or are banned in the context of peaceful assemblies. However, there are still serious challenges to the full enjoyment of assembly, association and free expression rights.



of news and human rights organisations' reports and other data, to elucidate the range and scope of injuries from the use—and misuse—of CCWs.

Since then, the nature, scale, and documentation of protests—and the weapons used—have evolved considerably. There are numerous reports in the media and medical research about thousands of people with severe injuries resulting from CCWs: kinetic impact projectiles (KIPs) have caused permanent blindness, brain damage and internal bleeding; chemical irritants have caused trauma from the canisters, as well as respiratory, skin, and eye injuries from the chemicals; stun grenades have burned people; and acoustic weapons have damaged hearing. Many more injuries likely went unreported.

These accounts and the significant medical and scientific advances that have been published since the initial report's release demanded that we revisit the findings of LiD1. This updated publication, and the additional resources published on the *[Lethal in Disguise](#)* web platform, aim to advance our understanding of the health impacts of CCWs since the publication of LiD1 and seek to continue to raise awareness about the misuse and abuse of CCWs, the detrimental health effects that these weapons can have, and the impact of their use on the meaningful exercise of assembly, association and free expression rights.

We attempt to answer a number of questions. What has changed in our medical understanding of the consequences of the use and misuse of CCWs globally? What new threats do we recognize these weapons pose

not just to health but also to the meaningful exercise of assembly, association and free expression rights? In raising awareness about the misuse of CCWs, we seek to answer these questions and foster a global debate to develop further international standards and guidelines on the deployment of CCWs. Ultimately, our goal is to prevent injury, disability and death by providing information about CCWs and enabling people to exercise assembly, association, and free expression rights safely and freely.

This report examines many categories of CCWs used around the world: including kinetic impact projectiles (KIPs), chemical irritants, water cannons, disorientation devices and acoustic weapons. Because weapons not traditionally considered riot control agents are increasingly being used to police crowds, this report also addresses blunt force weapons (i.e. batons) and new frontiers in CCW technology such as drones, electronic control devices and direct energy weapons. International law concerning the use of force, with specific mention of CCWs, is also discussed.

The title of this update and our prior report is designed to make a fundamental reality clear -- CCWs are dangerous and can be lethal. It is time for this to be widely acknowledged. The global use of CCWs by government-controlled security forces on protesters has severe consequences to the physical health of both those targeted and bystanders not targeted, on the mental health of everyone involved, and on the enjoyment and safe exercise of fundamental civil and political rights.

Based on multiple expert interviews, this report also demonstrates that injuries have been

repeatedly exacerbated by disproportionate, indiscriminate and excessive use of these weapons. We are not intending to claim that public order and safety are not a legitimate state obligation. Too often, however, the use of force and CCWs are used in violation of local, state and international protocols, resulting in disproportionate and excessive use. Nearly all weapons can and are frequently used as indiscriminate tools of collective punishment against peaceful protesters, bystanders and disruptors alike, regardless of their vulnerabilities, actions or potential for causing harm. Some are inherently unlawful, just because they are indiscriminate.

Police violence is also frequently discriminatory and biased against marginalised groups, including racial, ethnic, political, religious, and other minorities, who too often face disproportionate deployments of force and weapons during protests. While the use of certain CCWs may be warranted in some cases to ensure the safety of the public and law enforcement officials, this study demonstrates that the vast majority of CCWs are not only unnecessary for this purpose, but their use runs directly counter to the objective of “public safety and order”.

## Summary of findings<sup>2</sup>

### Kinetic impact projectiles

KIPs—commonly referred to as “rubber bullets” or “baton rounds”—are bullet-like missiles used by law enforcement and security forces to deter conduct through the pain of impact. The findings of a systematic review of medical literature indicate that KIPs can cause serious injury, disability, and even death. Our updated research identified 2,190 people with injuries from KIPs reported in medical literature published over the last six years (2016-2021) globally; and at least twelve of the identified people died from their injuries with 945 suffering permanent disabilities. Ocular injuries, including blindness, account for 1,575 of the injuries reported (65% of the total number of injuries).

These data demonstrate that severe injuries are most likely when KIPs are fired at close range, when KIPs contain metallic components or when multi-projectile KIPs are used. Of note, the number of injuries from metal birdshot found in our literature review dwarfs those from other KIPs (82% of all injuries). Additionally, we found that from close range, some types of KIPs have a similar ability to penetrate the skin as conventional live ammunition and can be just as lethal. When launched or fired from afar, these weapons are inaccurate and can strike vulnerable body parts and cause unintended injuries to bystanders, especially when multiple projectiles are scattering from one firearm simultaneously. Our conclusion

---

<sup>2</sup> The health effects of KIPs and chemical irritants are described in detail because there is adequate medical data on associated injuries to conduct a robust analysis. For other weapons, we harness the growing social media landscape and the growth of online news media sources to identify and catalogue injuries reported resulting from weapons.

is that it is doubtful that these weapons can be used in a manner that is both safe and effective in a protest setting.

## Key findings on KIPs

- › Increase in use and injuries: Since the publication of LiD1, data on the use of KIPs to suppress mass dissent has more clearly illustrated the true health cost of the proliferation of KIPs in law enforcement and security forces worldwide. Focusing on literature published from 2016-2021, 2,190 persons were injured or killed by KIPs, mostly in protest settings, a number greater than LiD1's total of 1,984 persons reported as injured and killed based on literature published before 2016.
- › Multi-projectiles: The finding of widespread injuries from multi-projectile KIPs—where multiple projectiles are fired at once—demonstrates the harmful effects of these inherently indiscriminate weapons. They cannot effectively target a single individual or a single body part, and their use has resulted in serious injuries to targeted individuals (when they impact sensitive body parts) and to bystanders (when the projectiles miss the intended target, instead affecting those not targeted). The results of our analysis suggest that these weapons are more dangerous than single projectiles and leading us to call for a prohibition on their use as a first step in limiting harm from KIPs.
- › Metal pellets: The vast majority of reported severe injuries (82%) occurred

as a result of metal birdshot, a hunting munition pressed into service in several countries as a KIP. This report illustrates metal pellets' imprecision, indiscriminate nature, and unmatched capacity to maim.

- › "Hybrid" weapons: The development and proliferation of "hybrid" weapons that combine characteristics of KIPs with other CCWs, such as "pepper balls" or stun grenades that disperse rubber balls, are proliferating technologies that must be closely observed and evaluated.
- › Canisters misused as KIPs: Tear gas canisters, when fired directly at protesters, can be extraordinarily hazardous. These devices and their resultant injuries are reviewed in the chemical irritants section, but the ad hoc use of other weapons as KIPs must be further examined and regulated.

## Chemical irritants

Commonly referred to as "tear gas" and "pepper spray," chemical irritants include a variety of chemical compounds intended to irritate the senses. The general perception is that these weapons have mostly short-term effects that include irritation of the eyes, dermal pain, respiratory distress, and the psychological effects of disorientation and agitation. A systematic review of medical literature documenting the health effects of chemical irritants identified over 100,000 people who have been injured since 2015. At least fourteen people have died, all of them

because of trauma inflicted by the canister.<sup>3</sup> While chemical irritants are often thought of as causing minimal transient harm, our findings also identify longer-term risks, including permanent disability and death from their use and misuse.

### Key findings on chemical irritants

- › Extensive use, limited evaluation: Tear gas has continued to be used extensively around the world. While chemical irritants continue to be the primary crowd-control agent used by law enforcement and security forces to repress and disperse protests, there is almost no publicly accessible manufacturer or government-sanctioned literature on the composition, health or environmental safety standards on the use of these weapons.
  - › New ways of deployment: Beyond the use of traditional canisters, sprays, and grenades, the use of chemical irritants diluted in water cannons is a growing problem, with reports of resulting skin irritation and pain. There has also been growing use of other composite weapons, such as pepper balls or water cannons laced with chemical irritants, which complicate the identification of weapons, as well as the treatment of injuries.
  - › Canisters misused as KIPs: Dense and metallic tear gas canisters can easily cause fatal injuries when fired at the head or torso. All deaths reported in
- recent medical literature associated with tear gas have occurred due to impacts from military-grade tear gas canisters.
  - › New hazards recognized as a result of the airborne transmission of viruses, such as COVID-19: The extensive use of chemical irritants during the pandemic has increased the risk of adverse medical effects due to COVID-19's effects on breathing and the lungs, as well as the risk of infection through induced coughing or sneezing. While there is limited information on the incidence of COVID-19 in the setting of tear gas exposure, this issue continues to be of concern as the pandemic continues, and others will likely follow.
  - › Psychological impacts: The psychological impacts of the use of CCWs have not been extensively studied nor documented in the medical literature, but cases documented in this review indicate that exposure to chemical irritants may result in significant psychological effects, including potential long-term disability.

---

3 The deaths reported were primarily in Iraq where military-grade canisters were used.

## Other weapons<sup>4</sup>

### Water cannons

Water cannons are inherently indiscriminate, particularly at long distances. They can also make communicating with protesters difficult. Their intimidating size and appearance may cause panic leading to stampedes among protesters. We found that blunt trauma from their force has resulted in blindness, head trauma and fractured bones in a number of people. The use of coloured dyes, chemical irritants, or malodorants in conjunction with a water cannon is a form of collective punishment which underscores the potential for abuse of these weapons.

### Disorientation devices

Disorientation devices, also known as “flash-bangs” or stun grenades, create a loud explosion and, in some instances, a bright flash of light. They are made of both metal and plastic parts that may fragment during the explosion and therefore carry risks of blast injuries to targeted individuals and bystanders. Explosions that occur close to people have led to amputation, fractures, burns and death. Additionally, the ability to precisely place these thrown devices is questionable, especially when used in protest settings. There are frequent news reports and anecdotal evidence of injuries and deaths from these weapons, including reports of injuries to military, corrections, and other law enforcement officials while handling these devices.

## Acoustic weapons

Acoustic weapons, sometimes called sound cannons or sonic cannons, indiscriminately emit painful, loud sounds that have the potential to cause significant harm to the eardrums and delicate organs of the ears and may cause hearing loss. Eardrum injury and hearing loss have been reported in a handful of lawsuits and other cases; serious questions remain about their safety and efficacy in protest contexts.

### Blunt force weapons

Blunt force weapons (i.e. batons) are perhaps the most recognizable police weapon used against protesters. These include many variations of a stick or club, depending on history, culture and context. Batons can be defensive weapons, but in the context of protests, they are frequently used as offensive weapons, sometimes in conjunction with other weapons, to shove, strike, hold or apply pressure on people. Batons, depending on the force and the location of the strike, can cause anything from mere bruising to life-threatening blunt trauma. We highlight cases in Italy, India, Chile and Kenya that illustrate the potential for abuse of batons in protests and demand broad regulation of the use of this type of weapon in protest settings.

---

<sup>4</sup> Although to date there is limited evidence in the medical literature on the safety of water cannons, disorientation devices, acoustic weapons, blunt force weapons (batons) and remotely operated vehicles, case studies involving these weapons demonstrate their capacity for causing significant harm to protesters.



## New frontiers<sup>5</sup>

### Electronic conduction devices

Electronic conduction devices (ECDs), such as tasers and electric shields, are transitioning from weapons used primarily in arrest or carceral settings to protest contexts. Cardiac arrhythmias, muscle damage and electric burns (both on the skin and internally) may result from electrical conduction, and there may be trauma from the barbs or shields that compounds the danger. ECDs have been identified as contributing factors in over 100 in-custody deaths in the United States as well as thousands of injuries globally. Expanding the use of these weapons to more people poses the risk of far more injuries.

### Remotely operated vehicles

Remotely operated vehicles, more commonly known as drones, have seen massive growth in the past decade. Civil liberties experts note that the use of drone technology is the most concerning CCWs development in the past five years. To date, they have been primarily used for surveillance, but they are increasingly being used to carry and fire CCWs. Both of these uses are problematic in terms of injury and the potential to violate fundamental rights.

These weapons may cause additional risk of injury because they can be employed remotely from the actual physical location of law enforcement or security forces, which can limit in-person judgements of how, when, on whom, and how much of a response

is appropriate. Mistakes are frequent in military drone strikes, and, by extension, any deployment of drones capable of firing CCWs in protest settings is concerning. To our knowledge, although drones that fire CCWs have only been used by Israeli law enforcement and security forces, a large number of countries have purchased these technologies, leading to concerns about their expanding use.

### Access to medical care

The health effects described in this report may be exacerbated by factors that serve to impede access to medical care. These include restricted access to medical transport, forbidding or restricting medical assistance at protests, direct attacks on medical professionals and street medics, and the chilling effect of detaining those injured by CCWs at medical facilities, which leads people not to seek necessary medical attention. These barriers to access to timely medical care have played a significant role in increasing the risk of serious injury, permanent disability, or death from CCWs.

## Summary of recommendations

Since LiD1 was published in 2016, we have seen both improvements and mounting challenges to limiting the dangerous use of CCWs. The initial report was well received and led to numerous national and international discussions around better regulation, resulting in the development of the 2020 *United Nations Human Rights Guidance on Less-Lethal Weapons in Law Enforcement*

---

<sup>5</sup> New frontiers in protest contexts include the use of electric weapons (such as tasers) and remotely operated vehicles such as drones.

(UN Guidance).<sup>6</sup> Protesters are now more aware of potential injuries and have better tools to report on their experiences. At the same time, weapons manufacture and use have proliferated, resulting in more injuries and less accountability for their harm. In many countries, there is still a lack of documentation, reporting and investigation of CCWs injuries. Meaningful accountability for CCWs abuses remains rare.

In the light of the evidence gathered in this report, INCLO and PHR, with contributions from the Omega Research Foundation, propose several recommendations on all aspects of CCWs use, including: regulating manufacturing and transparency in their design, composition, and testing, to regulating their trade and use; promoting the reporting of all uses of CCWs and seeking accountability for misuse. The purpose of the recommendations, found in detail in Section 4, is to reduce injuries, disabilities and deaths caused by CCWs; to bolster international guidelines for the use of CCWs; to ensure the protection and promotion of assembly, association and free expression rights; to seek accountability in cases of harm; and to develop safe practices for the occasions where these weapons are deployed.

These recommendations are based on two core principles: (1) protecting health and limiting injuries; and (2) ensuring the meaningful exercise of the right of assembly, association and free expression.

## Design, development, and procurement

- › CCWs and related equipment intended for use in the context of protests must be designed and produced in a way that ensures that they meet legitimate law enforcement objectives and comply with international law and standards. This duty applies to states and their agents as well as to companies that manufacture weapons for law enforcement (*recommendation 1*).
- › Information on CCWs, including manufacturer testing data and safety data sheets, must be made publicly accessible (*recommendations 5-6*).
- › International, regional and national controls should be adopted on the trade in CCWs and equipment. These should prohibit the trade in inherently abusive weapons and equipment and control the trade in CCWs that are misused to ensure that they are not used in human rights abuses (*recommendation 7*).
- › Testing, evaluation and approval should include a multidisciplinary approach that, in addition to law enforcement and manufacturers, includes policymakers, academics, health professionals and other relevant civil society actors. Testing of CCWs should consider, at the least, legality, level of target accuracy, risk of lethality, risk of serious injury or disability, level of pain inflicted, operational

---

6 United Nations Office of the High Commissioner for Human Rights, United Nations Human Rights Guidance on Less-Lethal Weapons in Law Enforcement, 2020 (UN Guidance on LLWs), accessible at: [https://www.ohchr.org/Documents/HRBodies/CCPR/LLW\\_Guidance.pdf](https://www.ohchr.org/Documents/HRBodies/CCPR/LLW_Guidance.pdf).

lifespan, reliability (i.e., minimal risk of malfunction) and other relevant factors (*recommendations 8-13*).

- › Selection and procurement of weapons must comply all domestic and international standards, and information about the process and the inventories should be made publicly accessible (*recommendations 14-16*).

## Regulations and training

- › States should engage with and support international- and regional-level processes to develop trade controls, including the United Nations (UN) process on controls on the trade in tools of torture (*call to the UN number 4*).
- › Regulations, procedures, and/or protocols on the use of CCWs should be developed for law enforcement based on applicable domestic, regional and international laws. Treaty obligations and international standards should be observed and operationalized in the protocols. These should also reflect the findings from independent testing. Law enforcement should never rely solely on manufacturers' instructions (*recommendation 17*).
- › Law enforcement should be trained in human rights and legal standards as well as human rights-compliant use of CCWs. In addition to teaching the technical aspects of the weapon and its use, training should be contextual, including addressing the specific aspects and challenges of managing protests in compliance with all

international, national and local laws (*recommendations 19-27*).

## Use of force

- › The use of any kind of force, including CCWs, must always comply with the principles of necessity, proportionality, legality, precaution, non-discrimination, and accountability (*recommendation 28*).
- › Appropriate de-escalation techniques should be used to minimise the risk of violence. Law enforcement officials should be aware that even the display of CCWs may escalate tensions during protests. Where force is proportionate and is necessary to achieve a legitimate law enforcement objective, all possible precautionary steps must be taken to avoid, or at least minimise, the risk of injury or death (*recommendations 29-30*).
- › Where a decision to disperse a crowd is taken in conformity with domestic and international law, force should be avoided. Where that is not possible under the circumstances, only the minimum force necessary may be used, with consideration of proportionality, and then only after very clear warnings and opportunities to comply have been made (*recommendations 31-34*).

## Deployment of crowd-control weapons

- › This report makes it clear that KIPs can cause serious injuries, permanent disability and even death. Severe injuries

are more likely when KIPs are fired at close range. When launched from afar, these weapons are often inaccurate and can strike vulnerable body parts or bystanders. Therefore, the medical evidence in this report underscores that KIPs should never be fired indiscriminately into groups and are, in general, an inappropriate weapon in any protest context (*recommendation 36*).

- › Chemical irritants, when deployed using canisters or grenades, are inherently indiscriminate by nature, cause severe pain and injuries and frequently escalate tensions. Therefore, extreme caution must be used before and during deployment, including considerations of the presence of bystanders and the existence of areas of egress and airflow to minimise any risk of overexposure due to serious risk of injury (*recommendation 41*).<sup>7</sup>
- › Many CCWs, including water cannons and acoustic weapons, are indiscriminate in nature and must be restricted and, if used at all, used with extreme caution in protest contexts (*recommendations 44-46 and 51-53*).
- › Batons should only be used in exceptional circumstances and only against violent individuals posing

significant risks to themselves or others (*recommendations 54-56*).

- › Some weapons have already been determined to cause disproportionate harm to health, undue collective punishment, or both, and must be prohibited. These include any kind of live ammunition (*recommendation 36*); KIPs that fire multiple projectiles at once, also known as “scatter shot” (*recommendation 38*); any projectiles with metal components or cores, including rubber-coated metal bullets, bean bag rounds and PVC-metal composite material, any projectiles with lead (*recommendation 39*); and pellet rounds, such as “birdshot” (*recommendation 40*); chemical irritants, including launchers that fire multiple chemical irritant canisters, such as the Venom system, excessively dense or high-grade canisters, canisters with additives or ingredients within them, sprays and grenades that are determined to be toxic or hazardous, have passed their expiration date or are otherwise in disrepair (*recommendation 42*); dye, chemical irritants or malodorants mixed with or sprayed with water cannons (*recommendation 47 and 48*); disorientation devices, such as stun grenades, explosive grenades or other flash bang weaponry (*recommendations 49 and 50*); direct

---

<sup>7</sup> INCLO member, the ACLU, supports these recommendations and, additionally, calls for a full prohibition of chemical irritants and all indiscriminate CCWs on any mass gathering or assembly. In July 2020, the ACLU submitted a [statement](#) to the United Nations Human Rights Council (UNHRC) which among other things stated that: “[p]olice response to protests and other mass assemblies should not involve militarized displays or mass violence by the government, and law enforcement should never deploy indiscriminate weapons, such as tear gas and stun grenades, on any mass gathering or assembly.” Several cities and states in the United States have proposed bills to ban or severely restrict the use of tear gas and/or KIPs in the context of protest. For example, the [City of Philadelphia](#), Pennsylvania, has categorically banned the use of chemical weapons and kinetic energy munitions by the police against any individual engaging in First Amendment activities.

contact electric shock weapons; some blunt force weapons, such as whips and weighted or spiked batons (*recommendation 56*); and fully autonomous weapons systems (*recommendation 58*).

- › Some weapons are concerning because of the risk of severe injuries or human rights violations. A moratorium on the use of these weapons in protest contexts should be issued until further evidence of their impacts has been collected and the boundaries of their lawful use have been established. These weapons include remotely operated armed drones, the development or use of directed energy weapons, and all other electric shock devices (*recommendation 58*).
- › For some weapons, the methods and contexts of use can exacerbate injuries, escalate tensions and compound rights violations. As a result, their methods of use must be restricted and limited. Specifically, firing in enclosed or confined spaces, using excessive quantities, exposing vulnerable individuals, including children, the disabled and older persons, and/or firing weapons directly at individuals or into dense crowds (*recommendations 37 and 43, 54-55, and 57*).

## Post-deployment procedures and accountability

- › Medical care for sick and wounded people must not be restricted or interfered with and identities of those seeking care should not be released to

law enforcement (*recommendations 59-61*).

- › Law enforcement officials should record and report any use of CCWs, including specific models of CCWs deployed, the distances from the targeted individuals and/or bystanders and duration of deployment, the number of each type of CCW used, and the specifics of any injuries caused by CCWs. Review of this reporting must confirm that the reporting is accurate, and that the use of CCWs was proportionate, necessary, and lawful (*recommendation 62*).
- › There should be a visible identification and a clear chain of command whenever CCWs are used, in order to ensure responsibility and accountability. All decisions taken should be traceable, and those who have taken them must be held accountable (*recommendations 63-64*).
- › All deaths, injuries and suspected misuses of CCWs should be thoroughly investigated by a body independent of the implicated officials, with a view to establishing responsibilities and accountability of the officials involved, including the various levels of the command structure in charge during the incident. Where there is evidence of unlawful conduct, commanders and responsible officers should face administrative disciplinary measures and/or criminal prosecution, as appropriate (*recommendations 65-67*).





Section 1

# INTRODUCTION

LONDON, ENGLAND, UK - MAY 1, 2021: "KILL THE BILL" PROTEST AGAINST POLICE, CRIME, SENTENCING AND COURTS BILL 2021. LOREDANA SANGIULIANO | SHUTTERSTOCK

Freedom of assembly and expression are under threat around the world.

Respect for assembly, association and free expression rights is one of the key indicators of a government's respect for human rights<sup>8</sup> and one of the pillars of modern democracies. The respect for the exercise of these fundamental freedoms often rapidly declines when people exercising their rights challenge or criticise their governments or when protests are organised to oppose government policy, leaders, or powerful non-state actors.

Since 2020, there has been growing awareness of the role and power of popular protests in which people have taken to the streets to express grievances and claim their rights. Widespread protest movements have pursued causes relating to racial justice,

environmental rights and climate justice, indigenous and land rights, women's rights, LGBTQ+ rights, minority rights, labour and political rights, public health-related matters, and thousands of other issues that together have swept across the world, leaving no continent untouched.

In many cases, law enforcement has responded in a manner that profoundly undermines fundamental human rights, including freedom of peaceful assembly and association and freedom of expression, among others - often leading to escalations in violence through unwarranted, inappropriate, or disproportionate uses of force. This trend is not exclusive to authoritarian governments; democratic governments have often responded with unlawful violence to lawful acts of protest. Most notoriously, law enforcement around the world has

---

8 See, among others, United Nations Congress on the Prevention of Crime and the Treatment of Offenders, Basic Principles on the Use of Force and Firearms by Law Enforcement Officials, 1990 (UN Basic Principles), accessible at: <https://www.ohchr.org/en/instruments-mechanisms/instruments/basic-principles-use-force-and-firearms-law-enforcement>.

used crowd-control weapons (CCWs), also known as less-lethal weapons, to disperse protests, arrest protesters, and quash any form of assembly. The consequences of the extended and growing use of these weapons have ranged from mild to severe injuries, including deaths.

In 2016, the International Network of Civil Liberties Organisations (INCCLO) and Physicians for Human Rights (PHR) published a first-of-its-kind report, *Lethal in Disguise: The Health Consequences of Crowd-Control Weapons* (LiD1). It provided the most comprehensive evaluation to date of the medical issues around the use of CCWs and how they are used to repress the rights to free speech and assembly. Since LiD1, CCWs are still used in responses by law enforcement<sup>9</sup> to popular protests, mainly through interventions consisting of large-scale crowd dispersal operations using these weapons indiscriminately.

Also known as “riot-control weapons,” “non-lethal,” “less lethal,” or “less than lethal” weapons, CCWs include kinetic impact projectiles (KIPs),<sup>10</sup> chemical irritants, acoustic weapons, water cannons, stun grenades, electrical conduction devices, and directed energy weapons, among others. We employ the term “crowd-control weapons”

(CCWs) to denote both the weapons being discussed *and* the context of their use. As protests continue, despite the COVID-19 pandemic, and more repressive responses by states, including CCWs abuses, continue to expand, we now update and strengthen our initial reporting. *Lethal in Disguise 2: How Crowd-Control Weapons Impact Health and Human Rights* examines the continued use and abuse of CCWs, expands the discussion of legal and contextual dimensions, and explores historical and modern trends in policing. As a result of our ongoing research, we have also established the Lethal in Disguise platform, a web-based portal which includes additional CCWs-related resources. It is accessible at [lethalindisguise.org](http://lethalindisguise.org).

CCWs have been misused in many flagrant incidents around the world since LiD1 was published six years ago, and they became more prominent during the COVID-19 pandemic - whether as a part of ongoing social movements as in Chile, Hong Kong, and India or catalysed by ineffective governmental responses to the pandemic as in Brazil.<sup>11</sup> New protests have also emerged during the pandemic in response to police brutality, both inspired by the Black Lives Matter (BLM) movement and due to ongoing human rights violations like the anti-SARS protests in Nigeria and the national strike in

---

9 Throughout this report, we use the term “law enforcement” to encompass a broad definition of police and security forces. In particular, we rely on the definition of “law enforcement officials” used in the Basic Principles *id*, which “includes all officers of the law, whether appointed or elected, who exercise police powers, especially the powers of arrest or detention. In countries where police powers are exercised by military authorities, whether uniformed or not, or by [s]tate security forces, the definition of law enforcement officials shall be regarded as including officers of such services.”

10 KIPs are among the types of weapons police use in the context of protests, but there is debate on whether it is proper for them to be included under the umbrella term of “crowd-control weapons.” This infers that they are appropriate tools for the management of assemblies, including to disperse assemblies. However, as the research in this section demonstrates, KIPs are dangerous weapons that are difficult to target in the context of protests and can cause serious injuries or even death.

11 See INCCLO, *Protesting during a pandemic: State responses during COVID-19*, April 2021, accessible at: <https://files.incclo.net/content/pdf/55/Protest-and-State-Response-V7.pdf>.

Respect for assembly, association and free expression rights is one of the key indicators of a government's respect for human rights and *one of the pillars of modern democracies*.

Colombia. These cases and others point to a growing trend of law enforcement using CCWs against crowds in inappropriate, unnecessary, unlawful, and disproportionate ways, causing severe and even fatal injuries.

## Methodology and limitations

The findings in this report are based on research conducted jointly by INCLO and PHR, first from 2014-2015 and then from 2021-2022. This additional research expands on and updates our original findings and recommendations in LiD1. There are complex linkages among laws and policies directed at protests, policing norms, and technological advances in CCWs that put both human rights and health at risk. We cannot properly understand the health impacts of CCWs without exploring the legal standards, the cultural and historical practices of law enforcement, the push-pull tensions between entrenched practices and reform, and the medical evidence. As such, this report is based on a triangulation of multiple methods: interviews, desk research, systematic reviews of peer-reviewed medical literature, and case study analysis.

In this version, we have updated our extensive research on CCWs, including chemical irritants, KIPs, acoustic weapons, water cannons, stun grenades, directed energy

weapons, and added reviews of blunt force weapons (i.e. batons), electrical conduction devices, and other emerging tools and technologies. Research topics included a history of the weapons, mechanisms of action, and an analysis of the harms produced by their use. Significantly, we developed case study examples from INCLO members to demonstrate the concrete realities on the ground in different contexts.

The analysis of the identified CCWs, their use, and their impact required diverse methods of inquiry and investigation. We followed the Preferred Reporting Items for Systematic Reviews and Meta-Analyses (PRISMA) guidelines to conduct systematic literature reviews of peer-reviewed publications that documented the health impacts of KIPs and chemical irritants. The searches for these two weapons were limited to peer-reviewed medical journals and publications to ensure high-quality data. Papers were included if they were published between 1 January 2015 and 28 February 2022 and documented symptoms, injuries and/or deaths associated with these weapons. Given the dearth of published studies, searches included publications discussing the use of these CCWs in protests, military or police training exercises, accidental discharges, and other police use in different contexts. Full details on the methodology we used is available in

previously published research papers.<sup>12</sup> In this report, prior data were updated, and the findings were revised to highlight changes and emphasise ongoing concerns.<sup>13</sup>

For other weapons categories, including water cannons, disorientation devices, acoustic weapons, batons, and other weapons, there is even less published data for review. In these cases, we also analysed case-series<sup>14</sup> describing the health effects of using these CCWs, using data available in medical journals, news media, social media, grey literature, human rights organisational reports, government reports and legal documents, among other sources.

While we sought to identify the full scope and range of injuries possible, the absence of systematic reporting requirements for deaths and injuries in crowd-control and protest settings makes it likely that the numbers of reported deaths and injuries are significantly underestimated. Moreover, comparative and risk analyses are not possible due to the lack of global data on the health impacts of these weapons.

To further contextualise documented injuries, between October 2021 and March 2022, we interviewed 22 civil liberties advocates from eighteen countries across six continents who litigate, advocate and work

on protest-related issues. These experts, all civil liberties lawyers who collectively bring years of experience in human rights, CCWs, and policing and civil liberties, were interviewed in their professional capacity. We conducted teleconference interviews and used deductive and inductive analysis to identify key themes from the interviews. The countries represented through these interviews are Australia, Argentina, Canada, Chile, Colombia, Hong Kong, Hungary, India, Indonesia, Ireland, Israel, Kenya, Nigeria, Russia, South Africa, Turkey, the United Kingdom, and the United States of America. These countries have a wide range of political and legal systems, recent protest themes, and cultural practices. The interview process was reviewed and approved by the UC Berkeley Committee for the Protection of Human Subjects (*Protocol ID: 2021-08-14599*).

In 2016, LiD1 was the first rigorous effort to explore how law enforcement uses CCWs to perpetrate human rights violations in the course of managing protests and the health effects of these practices. This second edition builds on that foundation by expanding our knowledge of the health impacts of CCWs while also exploring the legal and practical contexts in which they are used. This research underpins concrete recommendations for strengthening standards and regulations

---

12 RJ Haar *et al.*, "Health impacts of chemical irritants used for crowd control: a systematic review of the injuries and deaths caused by tear gas and pepper spray," *BMC Public Health* 17, no 1b (October 2017): 831, doi:10.1186/s12889-017-4814-6; and RJ Haar *et al.*, "Death, injury and disability from kinetic impact projectiles in crowd-control settings: a systematic review," *BMJ Open* 7 (2017): e018154, doi:10.1136/bmjopen-2017-018154

13 A systematic review of the literature is a rigorous methodology to identify literature on a subject. The PHR team adhered to PRISMA guidelines on the development of a systematic review protocol. See: D Moher, A Liberati, J Tetzlaff, and DG Altman, *PRISMA Group Preferred Reporting Items for Systematic Reviews and Metaanalyses: The PRISMA statement*, *PLoS Med.* 2009;6:e1000097. doi:10.1371/journal.pmed.1000097.

14 This refers to review and analysis of compilations of injuries prepared by other groups, and found in other sources, including news reports, government reports and medical literature.

around the manufacture, trade, and use of these weapons with the aim of strengthening accountability, enhancing oversight, and cultivating human rights norms.

In analysing the results of our review of the published literature, we recognize that this literature fails to document the entire scope of harm from CCWs. Our analysis can therefore provide only some insight into the range of potential injuries. Similarly, interviews with individuals working to advance human rights and civil liberties were designed to present a range of expert opinions and personal and professional experiences in diverse contexts. Our interviews were by no means comprehensive or representative of entire countries or populations.

## Trends and context of recent protests and movements

Interviews with the 22 civil liberties experts highlighted some overarching trends in social movements that may provide insight into why and when CCWs are used and the mechanisms by which they can cause injuries. These interviews were by no means representative of the geography or scope of protests in current times, but they build on decades of experience and expertise in countries with INCLO members.<sup>15</sup> Protests are complex and dynamic, and it is difficult to compare the frequency or size of demonstrations, marches, protests and other campaigns over the years. It is important, however, that the social movements that

took to the streets in recent years include those advocating for racial justice, women's and LGBTQ+ rights, and student and indigenous rights.

Anti-government protests, whether to protest authoritarian activities or economic corruption, have also been widespread. Public health protests since the beginning of the COVID-19 pandemic to protest mask-wearing or other lockdown measures also occurred in all regions of the world.<sup>16</sup> The health, economic and social emergency caused by the COVID-19 pandemic aggravated inequities affecting already marginalised communities in many countries. These included unjust labour practices, a lack of basic sanitation, inadequate living conditions and education, and unfair land use policies. Labour protests may not have received as much attention, but they were widespread and frequent.

The climate justice movement has also seen dramatic growth in the past five years; climate-related protests have been characterised by traditional marches and protests, but also school strikes by students. There have also been incidents of locking-on or protesting on private property, especially in relation to corporations engaging in oil and gas manufacture by those who have settled or function on indigenous land. Many of the above movements are interrelated and have mutually shared goals, participant communities and activities.

---

<sup>15</sup> I Ortiz *et al.*, "An Analysis of World Protests 2006-2020," in *World Protests* (2022), pp 13-81, Palgrave Macmillan, Cham, doi:10.1007/978-3-030-88513-7.

<sup>16</sup> See <https://www.icnl.org/covid19tracker/>.



In almost every case, law enforcement has been responsible for the management of protests. In some cases, special public order units have been deployed. In others, varying combinations of federal, state or local police have been deployed. In rare cases, the military or government security agencies have supported local police. On occasion, private security organisations or non-state actors have supported law enforcement operations.

Within law enforcement institutions, specific public order response teams that mobilise or respond to protests are frequently used. This is an area where experts noted increased militarization techniques, weapons and strategy. The use of private security personnel has also increased in responding to climate justice protests, such as in protests led by environmental activists against construction activities.

Many of our interviewees noted that the training of law enforcement officials and other personnel is often suboptimal and highly variable in the amount and quality of training on the foundations of protest

rights, the management of assemblies, and the appropriate use of CCWs. In general terms, they noted that police units had not been sufficiently trained in de-escalation techniques. That failure is evident in the way that law enforcement officials respond to protests and how often they resort to the use of force. In many countries, there is also a lack of training or any knowledge of protocols for the management of assemblies. Additionally, when military or reserve units are mobilised to support police, these units often have even less training in how to manage public gatherings or how to deploy CCWs safely.

Interviewed experts noted that law enforcement has also responded to protests in other ways beyond the use of force. Among these, surveillance of protests and protesters and arrests of organisers and others appear to be the most common measures. In almost every country studied, some form or another of surveillance technology is being used: tapping of the phones or social media activity of organisers; the use of video surveillance and facial recognition technologies during



protests; media monitoring programs; closed circuit televisions (CCTV); drone surveillance; and even UV-related or coloured dye in water cannons have been used to identify and track individuals.

Interviewees stated that, in many cases, protesters are arrested or detained, purportedly for being violent or threatening public order, safety, or national security, with limited to no justification. Frequently, these arrests are of non-violent people who are only exercising their rights to assemble and speak. While most people are released soon after their detention or arrest, there are many instances of ongoing cases. Land occupier movements are especially at risk of conviction. Intimidation and arrests have resulted in both the explicit and implicit chilling of protest rights.

## History and culture of policing

Civil liberties experts also spoke of the importance of the history and culture of policing and the crucial role the police play in understanding current police behaviours, especially concerning protests and the use of CCWs. There are significant differences across regions, countries, and even police departments within a country, and this section touches only on issues reported by the experts interviewed. They noted that historically, and in many contexts, racism, classism, and legacies of colonialism, political repression, authoritarianism, and slavery have influenced law enforcement practices. A deeply rooted culture of impunity has resulted in the normalization of excessive uses of force and repressive policing of

assemblies across the world. This history has often resulted in a military mentality of police, who treat protesters as the “enemy” rather than fellow members of their community whom they are entrusted to protect.

This history and culture, according to the interviewees, may also influence how police use the laws and their powers to restrict some protests and not others. Interviewed experts noted that often political protests and anti-government or anti-police brutality protests were treated with far more aggression than other types of demonstrations. In many contexts in which we conducted interviews, there is disproportionate repression of protest rights among socioeconomically, ethnically or culturally marginalised populations such as Black people, LGBTQ+ groups, Roma, indigenous groups, migrants and refugees. Journalists, particularly women journalists, have been targeted specifically or through a lack of specific protections in many protests. Interviewees noted that the level of repression of protests due to the viewpoints of the protesters had been based on a number of factors, including political affiliation and if the cause was perceived as opposing government or law enforcement practices. Anti-police violence protests, such as the BLM marches, for example, have been met with disproportionately high levels of violence. Per our interviews, the repression of environmental protesters has been a growing and concerning trend. In some countries, progressive or leftwing protesters also appear to face more severe uses of force or other repressive measures than conservative or right-wing protests.

IMAGE LEFT: POLICE IN RIOT GEAR SURROUNDED BY TEAR GAS AND PINK COLOR SMOKE BOMB IN TACTICAL TRAINING  
MR. NINO | SHUTTERSTOCK

# CROWD-CONTROL WEAPONS AND THEIR IMPACTS

WATER CANNON USED FOR CROWD CONTROL IN JERUSALEM DURING THE 2020 PROTESTS AGAINST BENJAMIN NETANYAHU OR BARENHOLTZ VIA WIKIPEDIA. | CREATIVE COMMONS

This section investigates CCWs in common use today: kinetic impact projectiles (KIPs), chemical irritants, water cannons, disorientation devices, acoustic weapons, blunt force weapons (i.e., batons), and several CCWs currently in the early stages of development. For each type of weapon, we review the weapon profile (history and description of the device), the mechanism of action (how the weapon works), and what is known about the health effects. In updating this report, we also summarise notable changes in the use, misuse, or advocacy related to each weapon since the publication of LiD1 in 2016. Recommendations regarding each type of weapon appear in [section 4](#).

This analysis is based on a review of medical literature, peer-reviewed scientific studies, legal documents, government reports, journalism, and photo-visual evidence. For the sections concerning impact projectiles and chemical irritants, we conducted systematic

reviews of peer-reviewed literature to update the literature discussed in the first report. This allowed for a detailed analysis of new patterns of injury observed over the last six years. We consulted with partner organisations of INCLC members who offered invaluable and alarming insights on the health impacts of CCWs. While not used as primary sources for this study, social media accounts of the misuse of CCWs brought to our attention emerging trends in these weapon systems.

In addition to updating the sections on KIPs, chemical irritants, water cannons, and acoustic weapons, we have added new sections on disorientation devices (“stun” grenades) and batons. In an additional section, we highlight emerging technologies and tactics—such as electronic control devices, directed energy weapons, and drones—that have the potential to be widely deployed in the near future.

Kinetic Impact Projectiles

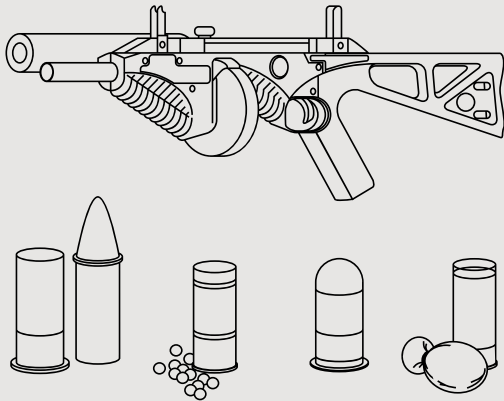

Disorientation Devices

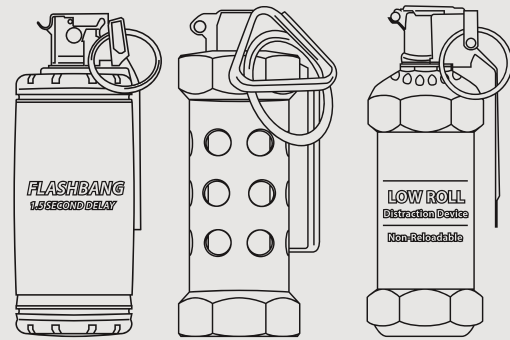

Chemical Irritants

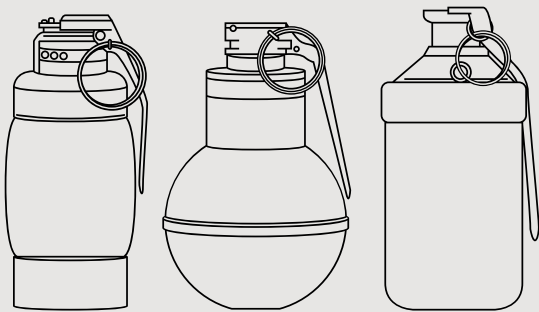

Acoustic Weapons

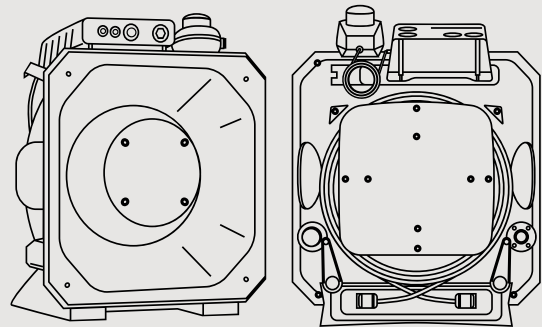

Water Cannons

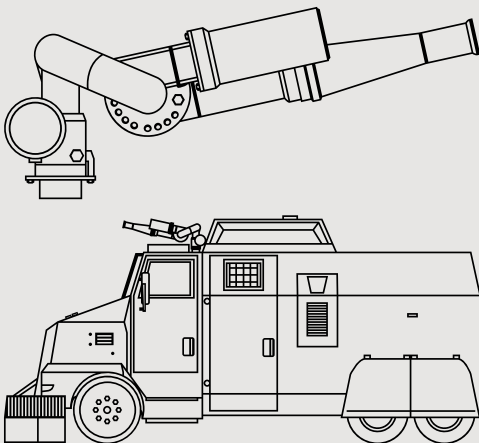

Blunt Force Weapons (Batons)

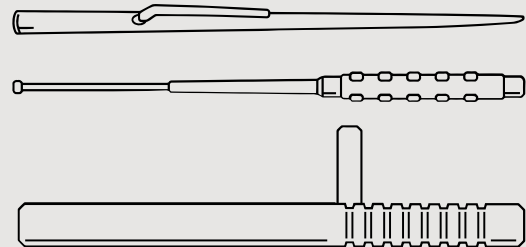





# KINETIC IMPACT PROJECTILES

BERKUT RIOT POLICE SHOOT RUBBER BULLETS TOWARD ANTI-GOVERNMENT PROTESTERS ON INDEPENDENCE SQUARE ON FEBRUARY 19, 2014 IN KIEV, UKRAINE. BRENDAN HOFFMAN | GETTY IMAGES

## Weapon profile

Kinetic impact projectiles (KIPs) are bullet-like missiles used in various law enforcement contexts as a deterrent through the pain of impact. Shot from firearms, these weapons were developed to offer the deterrent power of handheld baton strikes from greater physical distances. The staggering variety of KIPs has led to an abundance of common and trade names for what are often referred to as “baton rounds.” KIPs are most commonly dubbed “rubber bullets” regardless of their composition: modern KIPs are most commonly made of plastic (“foam-tipped plastic bullets,” “plastic baton rounds,” “sponge grenades,” “Flashball rounds”), metal (“rubber-coated metal bullets,” “pellets,” “birdshot,” “flexible baton rounds,” “bean bag rounds,” “Super-sock”), or other materials such as wood or rock salt.

The development of KIPs for crowd control is linked to the colonial policing of the British Empire. Early forms of KIPs used in protests were sawed-off pieces of wooden broom handles that were shot at rioters in Singapore in the 1880s. In the 1960s, slightly more advanced wooden bullets were developed in the United Kingdom and used against protesters in Hong Kong, Malaysia, and Singapore. The British Army initially developed wooden and then plastic polyvinyl chloride (PVC) and rubber bullets for use during the conflict in Northern Ireland. In parallel, the United States introduced rubber bullets to quell Vietnam War protests but temporarily halted their use in protests after a fatality in 1971. Over the past 40 years, the production of KIPs has spread from a few manufacturers in the United States and the United Kingdom to dozens of producers throughout the world. Manufacturers now produce more than 75 different types of



bullets and launchers.<sup>17</sup> Today, KIPs have found widespread use both in everyday policing and in crowd control as an addition to an arsenal that includes firearms, batons, chemical irritants, and more. The global CCW market was estimated at \$867.4 million in 2019 and is expected to continue to grow well into this decade.<sup>18</sup>

Some bullets are designed to be fired as a single missile, while others are fired as a group of small projectiles. The latter are sometimes known as “pellets,” “scatter shot”, or “multiple projectile rounds”, where many small- to medium-sized spheres are fired at a broad target. “Bean bag rounds” also consist of small metal pellets that are stitched into a synthetic cloth bag designed to expand on impact and therefore behave as a single projectile. Newer weapons include projectiles with a hard outer shell encasing chemical irritants that explode upon impact, or “attenuated energy projectiles,” where a hollow tip can limit the risk of ricochet or penetration by crushing into itself on impact.

Of special concern are metallic rounds used for crowd control. Due to their density and typically high velocities of impact, these pose greater inherent risks than rounds made of any other material. Rubber-coated metal

bullets designed as KIPs have been used for crowd control, and LiD1 highlighted the extreme danger posed by these weapons. This report highlights the impact of metal hunting bullets that have been arbitrarily designated “less-lethal” by virtue of protocols intended to reduce their lethality. While both types of weapons are used for crowd control in a similar manner to other KIPs, their inherent killing power has left a huge number of injuries, disabilities, and deaths in the wake of their use, as detailed further below.

KIP weapons exemplify the “elephant in the room” problem of less-lethal weapons: To date, no organisation, study, or report has clearly and objectively defined what makes a weapon lethal, less-lethal, or non-lethal—much less acceptably “safe.” The decision is typically left to the very organisations tasked with procuring CCWs—or the government entities demonstrators often protest against—to determine whether said weapons achieve a level of acceptable lethality. There are heterogeneous rules across countries and jurisdictions, ranging from allout bans to free use of all KIPs and many permutations in between.

---

17 Omega Research Foundation, “Crowd Control Technologies: An Appraisal of Technologies for Political Control” (Manchester, UK: European Parliament, Directorate General for Research, The STOA Programme, (June 2000), accessible at: [http://www.omegaresearchfoundation.org/assets/downloads/publications/19991401a\\_en.pdf](http://www.omegaresearchfoundation.org/assets/downloads/publications/19991401a_en.pdf). See, also, Global Non-Lethal Weapons Market Report 2013-2018. Manufacturing of KIPs takes place in locations as diverse as Brazil, China, Israel, South Africa, South Korea, and the United States.

18 Grand View Research, “Less Lethal Ammunition Market Size, Share & Trends Analysis Report By Weapon Type (Shotguns, Launchers), By End Use (Law Enforcement, Military), By Product, By Region, And Segment Forecasts, 2020 - 2027,” accessible at: <https://www.grandviewresearch.com/industry-analysis/less-lethal-ammunition-market>.

## Sidebar

## Defining “lethal” versus “non-lethal”

Clearly defining “lethal” versus “non-lethal” projectiles has proven difficult. Most physical based guidelines for defining less-lethal impact projectiles stem from a 1977 pilot study by the United States Army’s Human Engineering Laboratory, which established an “extensive damage” threshold of 90 foot-pounds (approximately 120 joules) of kinetic energy of impact, beyond which severe damage to the human body was highly likely.<sup>19</sup> However, this threshold was arrived at through tests with approximately 1-inch diameter rubber spheres; while kinetic energy considers only mass and velocity, the form of a projectile strongly also affects its terminal behaviour.

For instance, a pellet of U.S. #6 birdshot (a common size used by Indian police, approximately 3mm in diameter) has an approximate mass of 0.126g and a muzzle velocity of 365 m s<sup>-1</sup>, yielding a kinetic energy at the muzzle of ~8 joules, well below the so-called lethal threshold. However, metal birdshot is universally accepted to be lethal at close range and hazardous to the eyes at

longer distances, due in large part to its ability to penetrate tissues even at extreme ranges. “Energy density”—or how much kinetic energy is distributed over impact area—is a more relevant metric for evaluating penetration. Birdshot’s energy of impact is focused on a very small area (birdshot ranges in diameter from <1 to 6 mm), which accounts for its high risk of penetration and accordingly high potential for injury.

The ambiguous physical principles behind projectile lethality must be kept in mind when authorities claim a particular CCW is “non-lethal.” This uncertainty can, in some circumstances, allow for exceptionally hazardous weapons to be utilised in crowd control contexts. A more nuanced approach to evaluating lethality would rigorously test factors beyond impact energy, such as energy density, projectile precision, and human factors of use,<sup>20</sup> although to date testing that is both comprehensive and publicly available has not proven forthcoming.

19 DO Egnor, “Evaluation of Less-Lethal Weapons,” *U.S. Army Human Engineering Laboratory Technical Memorandum*, 37-77, (December 1977) at p 194, accessible at: <https://www.ojp.gov/ncjrs/virtual-library/abstracts/evaluation-less-lethal-weapons>.

20 The “SWAPDEC” testing protocol considering speed, weight, accuracy, precision, density of impact energy, effective range, and consistency comes closest to a standard of testing that could effectively anticipate health risks of an impact munition under consideration for use. See RT Wyant and T Burns, *Risk management of less lethal options: evaluation, deployment, aftermath, and forensics*, CRC Press, (2014).

## Mechanism of action

<b>Kinetic Impact Projectile</b>	<b>Rubber or plastic bullets</b>
<b>Alternative Name(s)</b>	Baton rounds, Riot rounds, "Flash-Ball" rounds
<b>Composition/Description</b>	<ul style="list-style-type: none"> <li>• Solid, spherical or cylindrical projectiles of variable sizes made solely of hard rubber, plastic, or polyvinylchloride (PVC)</li> <li>• May be fired as single shots or in groups of multiple projectiles within a cartridge</li> </ul>
<b>Mechanism of Action</b>	Less dense than metal bullets to limit force on impact
<b>Range and Usage</b>	<ul style="list-style-type: none"> <li>• Many guidelines suggest they are designed to fire at the target's legs or at the torso (to avoid hitting the head, face or genitalia)</li> <li>• Muzzle velocity and force on impact are dependent on variable shapes and fills within cartridges that can affect flight patterns</li> </ul>



ROBIN BALLANTYNE | OMEGA RESEARCH FOUNDATION

<b>Kinetic Impact Projectile</b>	<b>Scattershot or multiple projectile rounds</b>
----------------------------------	--

<b>Alternative Name(s)</b>	Multi-projectile, Sting ball, Rubber pellet rounds
<b>Composition/Description</b>	Similar to baton rounds (above) but are fired in groups of multiple projectiles within one cartridge. Can range from 2 to dozens of projectiles ejected at once
<b>Mechanism of Action</b>	<ul style="list-style-type: none"> <li>• Similar to above in striking with force.</li> <li>• Multiple projectiles splay out over distance so farther distances will result in more spread of the shot and less discrimination in target. Closer ranges may result in multiple projectiles hitting a single individual</li> </ul>
<b>Range and Usage</b>	Muzzle velocity and force on impact are dependent on variable shapes and fills within cartridges that can affect flight patterns



ROBIN BALLANTYNE | OMEGA RESEARCH FOUNDATION

Kinetic Impact Projectile    Attenuated Energy Projectile (AEP)

Alternative Name(s)    AEP

Composition/Description    Hard plastic body and a hollow nose

Mechanism of Action    Hollow tip is designed to collapse on impact, limiting penetrative injury

Range and Usage    

- Intended to only fire at target's legs
- Specific weapon used primarily in the UK



Kinetic Impact Projectile    Rubber- coated metal bullets

Alternative Name(s)    (misleadingly called) plastic or rubber bullets

Composition/Description    

- Spherical or cylindrical projectiles with solid lead or metal core surrounded by a 2 mm coating of plastic or rubber
- (Core weight: about 16 g; diameter: 15.75 mm)
- May be fired as single shot or in groups up to 15

Mechanism of Action    Outer coating made of rubber to limit penetrating trauma but dense metal core augments operational range and force on impact.

Range and Usage    

- Intended to only fire at target's legs
- Similar to solid baton rounds, although metal core allows for greater retained velocity and impact force
- Primarily used in the Occupied Palestinian Territory by Israeli security forces



**Kinetic Impact Projectile**    **Flexible baton round**

**Alternative Name(s)**    Bean bag rounds, "Super-Sock"

**Composition/Description**

- Synthetic cloth bag filled with about 45 g of small metal pellets (100 pellets of #9 lead shot is most common)
- Greatest diameter for the bag is usually 6 cm

**Mechanism of Action**    A cartridge has wadding meant to expand and drop the wadding as it travels, creating a wider surface area blow

**Range and Usage**

- Intended to only be fired at target's legs
- Expansion of the bag is problematic at short distances leading to injuries



ROBIN BALLANTYNE | OMEGA RESEARCH FOUNDATION

**Kinetic Impact Projectile**    **Sponge rounds**

**Alternative Name(s)**    Foam-tipped plastic bullet, Sponge grenade

**Composition/Description**

- Projectile with a high-density plastic body and a hard foam nose designed to collapse upon impact
- Fired from 37- or 40-mm grenade launchers

**Mechanism of Action**    Large surface area and relatively soft tip intended to limit penetrative injury

**Range and Usage**

- Minimum engagement range is 10 – 15 m, and maximum effective range is 50 m
- Designed as "direct fire" at target's less vulnerable anatomy (legs)



ROBIN BALLANTYNE | OMEGA RESEARCH FOUNDATION



**Kinetic Impact Projectile    Pellet rounds**

**Alternative Name(s)**    Birdshot, buckshot

**Composition/Description**    Cartridges filled with plastic, rubber, steel or lead balls that spread out when fired.

**Mechanism of Action**    Smaller than scattershot (multiple projectile rounds), these smaller pellets have a wider dispersal pattern and less acute aim. Metal pellets are dense and have a higher kinetic energy.

**Range and Usage**    Causes an indiscriminate spray of munitions that spreads widely and cannot be aimed. Lead and steel pellets in particular cause significant injuries, especially if they hit the eyes.



**Kinetic Impact Projectile    Plastic-metal composite bullets**

**Alternative Name(s)**    (misleadingly called) plastic or rubber bullets

**Composition/Description**    A composite of plastic and silica, metal fragments, or small shards of metal (lead or steel) within a rubber, plastic, or PVC base

**Mechanism of Action**    Have higher density than solid plastic but less than metal bullets designed to extend firing range or force on impact from traditional baton rounds

**Range and Usage**

- Intended to only fire at target's legs
- Similar to solid baton rounds with higher speed and force on impact possible
- Variable shapes can affect flight patterns and force on impact



Kinetic Impact Projectile	Pepper-spray projectiles
Alternative Name(s)	“Pepperballs”, FN 303
Composition/Description	Plastic capsules fired from a compressed air gun similar to recreational paintballs, filled with PAVA/OC (“pepper” agent) or marking dye
Mechanism of Action	Combines kinetic impact from a projectile with a secondary chemical irritant
Range and Usage	<ul style="list-style-type: none"> <li>• Up to 50 meters advertised</li> <li>• Questions about accuracy</li> </ul>

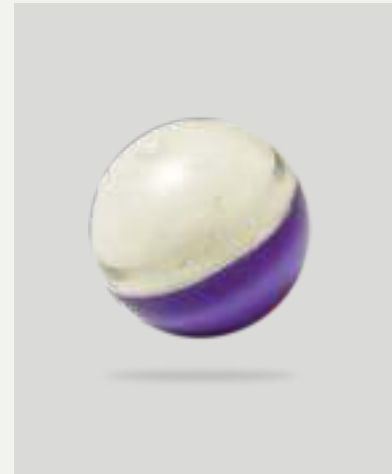

Figure 1: Selected types of Kinetic Impact Projectiles\*

\*Note: this table only includes some common types of KIPs and information gleaned from accessible sources

KIP weapons exemplify the “elephant in the room” problem of less-lethal weapons: To date, no organisation, study, or report has clearly and objectively defined what makes a weapon lethal, less-lethal, or non-lethal—much less acceptably “safe.”

A projectile weapon works by transferring kinetic energy (i.e., energy from movement) from an object in flight to a person. While lethal projectiles are constructed to maximise the likelihood of death by penetrating the skin to compromise vital organs, KIPs are ostensibly constructed to minimise penetration while delivering sufficient kinetic energy to produce significant pain and/or incapacitate an individual.

A projectile's impact force and propensity to penetrate depend on a number of factors, foremost among them their cross-sectional area and speed. Small, fast projectiles are more likely to penetrate the skin than large, slow projectiles. Many KIPs are designed to maximise the surface area of presentation to distribute impact force and reduce the probability of skin penetration or to minimise weight so that the projectile will quickly lose speed while in flight. The plasticity of a round, the number of projectiles fired at once, and protocols governing their use will all also affect how a projectile functions. In spite of design efforts to reduce lethality, KIPs can cause serious injury, permanent disability, and death if they hit critical parts of the body with significant force. To avoid potentially lethal uses of KIPs, manufacturers often establish protocols to avoid circumstances in which KIPs could prove fatal. First, as projectile velocity is greatest as soon as it enters ballistic flight (i.e. immediately after a bullet is fired), manufacturers often establish minimum use distances to reduce the impact velocity of KIPs.

Complexity arises when considering distance: older projectiles had a reputation for inaccuracy (especially when "bounce-fired" off the ground). While ballistic testing of newer designs has shown them to be capable of sufficient precision to keep rounds within the lower third of the body at operational distances, these operational distances can differ between weapons, be unclear in practical terms, and are frequently not maintained.<sup>21</sup> Second, manufacturers sometimes issue warnings that KIPs should never be shot at vital parts of the body, such as the head. However, guidelines on targeting parts of the body tend to be contradictory, some saying that the bullets should be aimed in the torso "box" between the clavicles and the hips, others noting that the upper torso should be avoided, and bullets should be aimed towards the lower legs. Given that police departments purchase multiple weapons for use in the same protests, and each weapon can have vastly different instructions, there is frequent confusion and misuse.

Use protocols help to mitigate the human hazard of KIPs, although they are by nature imperfect and do not eliminate the objective hazard inherent in ballistic weapons such as KIPs. Minimum engagement distances are often difficult to follow in dynamic, high-stress situations, such as crowd control, which can lead to inadvertent deployment at dangerous ranges. Directives to target specific body parts are heavily contingent upon the training and stress response of users, with the latter having been demonstrated to add

---

21 I Ndindabahizi et al., "Error Budget of Non-lethal Projectiles Using Stochastic Simulations," *Human Factors and Mechanical Engineering for Defense and Safety* 3, (August 2019), a p 10, doi:10.1007/s41314-019-0029-1.

significantly to the inaccuracy of KIPs.<sup>22</sup> These human factors are exacerbated by the minimum operational ranges imposed to limit the damage caused by KIPs—longer engagement distances make it more difficult to accurately target specific body parts and more likely that projectiles may fly astray.

### Multiple projectile KIPs

Multiple projectile KIPs, which fire more than one projectile per shot, best illustrate the irreconcilable nature of protocols demanding pinpoint accuracy at extended ranges. When fired, these projectiles spread out in a cone from the muzzle of the weapon, resulting in progressively greater imprecision with distance. At longer distances, projectile dispersion renders these projectiles impossible to place precisely, increasing the likelihood that projectiles may accidentally impact other parts of a target's body or other individuals entirely. This risk is greatly exacerbated by the large number of projectiles in flight with the use of these weapons, which is tens to hundreds of times greater than that of single projectile rounds.

The metal pellets described earlier in this section illustrate the danger posed by a failure to understand the interaction among these risk factors. Colloquially known as "birdshot," these are hunting rounds fired as a single group of tens to hundreds of high-velocity metal spheres. While indisputably lethal at close range, the minimum distance of use (e.g., 50 metres in India)<sup>23</sup> is designed to be far enough to ensure that pellets have lost sufficient velocity so as to render them non-lethal. However, even beyond 50 metres, pellet guns have the ballistic capacity to penetrate some organs, such as the eyes, causing blindness.<sup>24</sup> The vast number of individuals gravely injured by birdshot used as a CCW is a testament to the regrettable ignorance of the danger posed by any use of these potentially lethal rounds.

The use of potentially lethal weapons as KIPs is perhaps unsurprising given that there is little published research on the safety of KIPs. There is an overall lack of transparency by manufacturers and policing organisations regarding the type of safety testing KIPs have undergone and under what conditions. The dozens of weapon types on the market

**Multiple projectile KIPs, which fire more than one projectile per shot, best illustrate the irreconcilable nature of protocols demanding pinpoint accuracy at extended ranges.**

22 J Taverniers and J Suss, "A user-centred assessment of a less-lethal launcher: the case of the FN 303 in a high-pressure setting," *Ergonomics* 62, no. 9, (2019), at pp 1162-1174, doi:10.1080/00140139.2019.1626916.

23 ScSaaliq, "Pellets: Lethal or not?" Hindustan Times, (July 28, 2016), accessible at: <https://www.hindustantimes.com/static/lethal-pellets/>.

24 B. Perrigo, "Faces in the Darkness: The Victims of 'Non-Lethal' Weapons in Kachmir," Times, 6 September 2018. Accessible at: <https://time.com/longform/pellet-gun-victims-kashmir/>.

can generate considerable confusion about their proper use, as protocols developed for some KIPs may not apply to others. Lack of transparency on the part of manufacturers also limits the information that health care providers can use in assessing injuries.

KIPs are marketed to military, police, and private security forces in nearly every country, with little or no regulatory oversight or accountability. Protocols on the use of KIPs by police and military or by manufacturers are not usually publicly available. Available use-of-force guidelines generally recommend that KIPs be used only for individual force-control rather than on groups of people. Nonetheless, evidence from photographs, video cameras, and testimonials in many countries identifies the frequent violation of these guidelines. There are examples of KIPs being aimed at the upper body or face, being fired from very short distances, being used against non-threatening individuals, and being fired indiscriminately at crowds as a means of collective punishment.<sup>25</sup> Even when used according to protocol, slight errors in distance estimation or aim can instantaneously make a supposedly “less-lethal” weapon lethal. Worldwide reports of KIP injuries to critical areas of the body—as well as injuries to innocent bystanders—are testaments to this unacceptable risk.

## Health effects

### Overview

The health impacts of KIPs depend on a number of factors, including the type of projectile, the characteristics of the weapon it is shot from, the distance from which the shot is fired, the user’s skill, and the inherent imprecision of the weapon itself. Although KIPs are designed to minimise penetration and limit the force of blunt trauma, injuries from both mechanisms have been documented.

Most KIPs are propelled by a powder charge and are best considered a subcategory of firearm. KIP injuries, like all trauma and specifically firearm injuries, can be non-penetrating, where the pellet does not enter the skin or tissue (such as blunt force trauma) or penetrating (where the pellet does enter and in the case of perforating injuries, also exits the tissue). KIPs can cause both types of injury. The severity of injury from bullets is dependent on the missile energy on impact (related to projectile mass, distance, and muzzle velocity), missile design (including the calibre and shape), and the characteristics of the target tissue.<sup>26</sup>

KIPs can cause severe injuries through both blunt and penetrating trauma. Blunt trauma directly damages tissue by crushing but can also lead to potentially life-threatening injuries from organ rupture, bone fracture, and internal haemorrhage. Blunt impacts to

---

25 S Reynhout, RJ Haar, and M Heisler, “Shot in the Head,” *Physicians for Human Rights* (14 September 2020), accessible at: <https://phr.org/our-work/resources/shot-in-the-head/>.

26 Z Gugala and R Lindsey, “Classification of Gunshot Injuries in Civilians,” *Clinical Orthopaedics and Related Research* 408, (March 2003), at pp 65-81, accessible at: [https://journals.lww.com/clinorthop/fulltext/2003/03000/classification\\_of\\_gunshot\\_injuries\\_in\\_civilians.7.aspx](https://journals.lww.com/clinorthop/fulltext/2003/03000/classification_of_gunshot_injuries_in_civilians.7.aspx).



the head pose a very high risk of traumatic brain injury. Tissue damage from penetrating and perforating wounds can cause laceration of skin and solid organs, stretching of tissue in the track of the projectile and shockwaves of pressure in the tissue. Penetrating trauma to the brain causes traumatic brain injury, such as skull fractures and intracranial haemorrhage and is often instantly fatal. Piercing the heart or lungs directly compromises the circulation system and the body's oxygen exchange system, which can result in death within minutes. Severed arteries can also lead to rapid death through exsanguination (bleeding out). Spinal cord or nerve injuries can be permanently debilitating, causing motor and/or sensory deficits. Injuries to other organs may require rapid emergency surgery to avoid fatality, given the risks of internal bleeding, organ damage, and secondary infection (particularly from bowel perforation). Furthermore, the risk of permanent disfigurement or disability is high from both blunt and penetrating trauma, either through compromise of non-vital organs (such as the eyes) or damage to the skin or musculoskeletal system.

### Results of the updated systematic review

We updated the systematic review of medical literature conducted in the previous version of this study with literature published from 2016 to 2021, following the same search and selection process that was followed in the first report.<sup>27</sup> Collectively, the systematic reviews identified 4,174 individuals injured by KIPs and 65 fatalities as a result of KIP impact. At

least 1,245 individuals have likely sustained permanent injuries as a result of KIPs.

Nineteen new studies were identified that met the inclusion criteria. (See the list of reviewed studies in the Appendix.) These

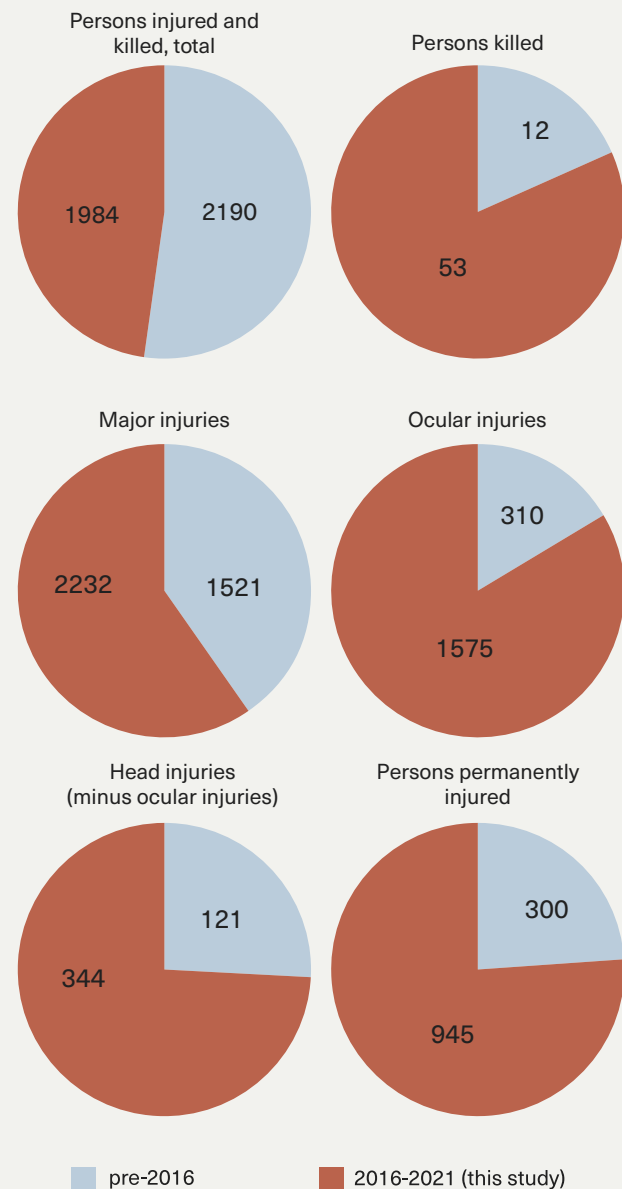

Figure 2: Comparison of selected statistics from *Lethal in Disguise* (2016) and this study (2016-2021).

27 The updated review identified scientific and medical literature pertaining to KIPs injuries published since the printing of the last version of *Lethal in Disguise* (2016-2021). Nineteen articles met inclusion criteria, had clear causation by KIPs, contained health impact data, and were of sufficient quality to include.

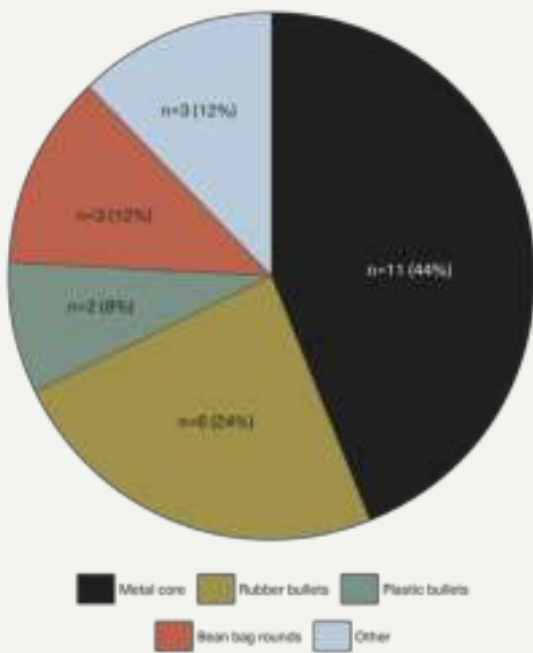

Figure 3. Types of weapons represented in the literature review. Several publications referenced multiple types of KIPs.

detailed 2,190 individuals injured by KIPs, compared to 1,984 found in the last report. Of these 2,190, 12 perished as a direct result of being shot with impact projectiles. All deaths occurred secondary to injuries inflicted by metallic projectiles. Compared to the previous report, over the last five years, the medical and scientific literature identified higher numbers of total individuals affected, major injuries, permanent injuries, head injuries, and ocular injuries (Figure 2). Deaths, on the other hand, declined. This does not necessarily indicate a relative increase in the use of less lethal weapons; rather, the high number of injuries over the past five years could represent an increasing awareness of and interest in documenting the health hazards posed by impact projectiles. These numbers should be considered a minimum estimate of the true health impacts of KIPs. Our review is limited in scope to solely the medical and scientific literature. Literature reviews are subject to selection

bias guided by research priorities, resources, geographic bias, and many other issues. Many individuals will not seek medical attention for their injuries due to economic constraints or fear for their personal safety and will, therefore, not be counted per our methodology.

### KIPs of special concern

Our report revealed injuries from metallic rounds (including “bean-bag” rounds), rubber rounds, plastic rounds, as well as hybrid rounds (such as “pepper-ball” guns, classified as “other”). In the previous report, so-called “pellet guns” firing metal pellets used for crowd control were not included in the literature review of KIPs. Since then, a host of literature regarding these weapons has been published, illustrating the highly indiscriminate and dangerous nature of metallic birdshot. The vast majority of the casualties from multi-projectile rounds come from the use of metal birdshot in Indian-

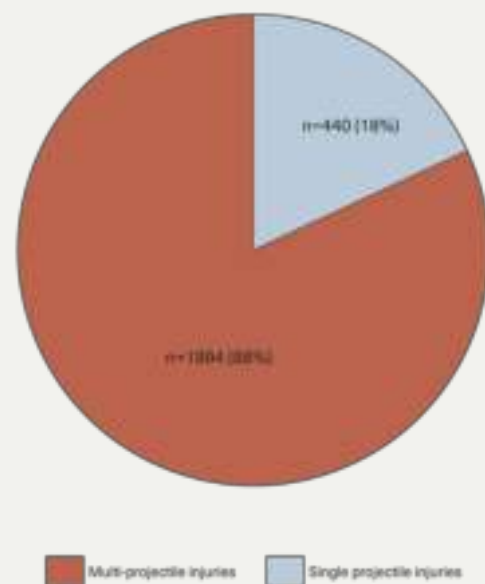

Figure 4. Total injuries (major and minor) from single and multi-projectile KIPs, this report.

controlled Kashmir. Their deleterious effect on public health is far out of proportion relative to any other kind of KIP. Birdshot is also unique as an unmodified lethal munition made non-lethal only on a technicality by protocols of use and laws in a given country. While fewer than half (n=9) of the studies identified pertain to these weapons, they are responsible for 82% of the injured and killed in this review (Figure 4).

Two countries are almost wholly responsible for this tally: India and Chile, where different kinds of multi-projectile KIPs are widely used for crowd control.

Shotgun shells carrying hundreds of metal pellets have been used for over a decade for crowd control in the Indian Union Territory of Jammu and Kashmir. Often referred to as “birdshot” or, locally, “pellets,” these lethal rounds historically were used for hunting small game. Local police have arbitrarily labelled them “less-lethal” when fired from distances of over 50 metres; however, beyond this distance, the expanding cloud of dense, high-velocity pellets still have ample capacity to penetrate the skin and inflict grievous injuries. Metal birdshot from Kashmir alone accounts for 76% (n=1,669) of all dead and injured individuals captured in our review of the medical literature and 85% (n=1,323) of all ocular injuries. This tally is certainly an undercounting of the true prevalence of birdshot injuries in the region, which by independent accounting, is likely in the thousands.<sup>28</sup> In many cases, surgical

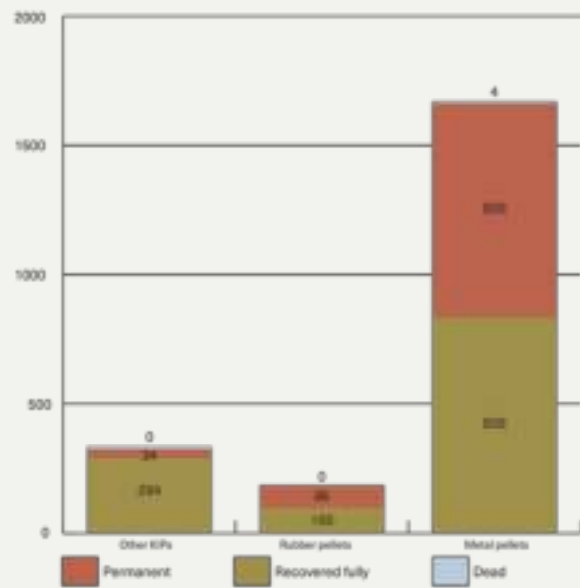

Figure 5. Deaths, permanent injuries, and recoverable injuries are sorted by single-projectile and multi-projectile KIPs

removal of birdshot is not feasible, and the social and economic cost of the longterm effects provoked by Kashmir’s “epidemic of dead eyes” will persist for decades.<sup>29</sup>

In Kashmir and elsewhere, the metal birdshot is primarily composed of lead, which, even in small doses, is known to cause physical and mental developmental and behavioural harm that can be devastating. Lead pellets, having once penetrated the skin, are difficult to remove. Moreover, due to their indiscriminate nature, children may be struck. Thus, the longer-term effects of lead poisoning from pellets must be better studied.

Multi-projectile KIPs are also responsible for the upsurge in ocular injuries reported in the literature in countries where they are being

28 Human Rights Watch, “India: Stop Using Pellet-Firing Shotguns in Kashmir,” *Human Rights Watch*, (4 September 2020), accessible at: <https://www.hrw.org/news/2020/09/04/india-stop-using-pellet-firing-shotguns-kashmir>.

29 E Barry, “An Epidemic of ‘Dead Eyes’ in Kashmir as India Uses Pellet Guns on Protesters,” *The New York Times*, (29 August 2016), accessible at: <https://www.nytimes.com/2016/08/29/world/asia/pellet-guns-used-in-kashmir-protests-cause-dead-eyes-epidemic.html>

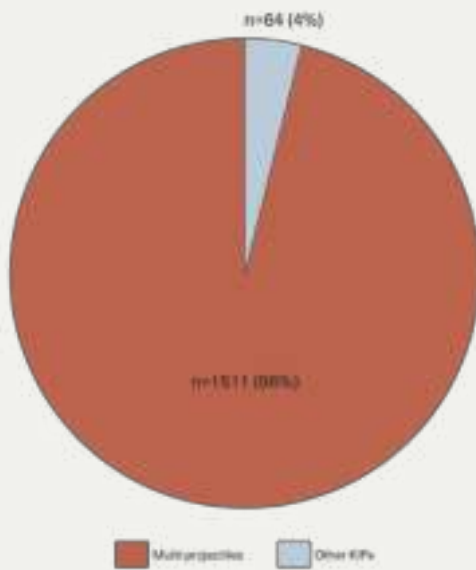

Figure 6. Ocular injuries caused by single projectile vs multi-projectile KIPs, this report.

used. These injuries are severe and consist of both closed- and open-globe injuries, which often require surgical intervention and, in almost all cases, leave the victim with reduced visual acuity or permanent vision loss in the affected eye(s).

Another example of the harms of multi-projectile KIPs comes from Chile. Chilean security forces used a kind of multiple projectile KIP known as “rubberized buckshot” during the nationwide protests starting in October of 2019, resulting in over 400 ocular injuries as a result of these KIPs.<sup>30</sup>

These projectiles, fired as a group of 12, are made of a composite material far denser than pure rubber. Although less hazardous than birdshot, “rubberized buckshot” shares the characteristic of uncontrollable dispersion at a distance with its metal counterpart. Perhaps unsurprisingly, the pattern of injuries in our literature review is similar, with a high number of ocular injuries occurring (n=182) over a period of less than two months.

The number of injuries from metal birdshot found in our literature review dwarfs those from other KIPs. Metal birdshot is also responsible for all deaths not attributable to rubber-coated metal bullets. The disproportionate health impacts of metal birdshot demonstrate that these weapons should be considered lethal and must never be used for crowd control. Furthermore, the alarming similarities in ocular injury prevalence between metal birdshot and rubberized buckshot strongly suggest multiple projectile KIPs, in particular, pose a grave risk of disability. They likewise should be banned for crowd control.

**The disproportionate health impacts of metal birdshot demonstrate that these weapons should be considered lethal and must never be used for crowd control.**

30 N Larsson, “He saw white: Why the eye became a symbol of Chile’s unrest,” *Al Jazeera*, (16 March 2020), <https://www.aljazeera.com/features/2020/3/16/he-saw-white-why-the-eye-became-a-symbol-of-chiles-unrest>.

## Sidebar

## Pellets, buckshot, and birdshot

Historically, police have used shotguns to fire loads of metal pellets as an extreme method of crowd control. These weapons were used during the Attica Prison riot in 1971 and “Bloody Thursday” at People’s Park in 1969 in the United States, as well as throughout pre- and post-apartheid South Africa. While lethal rounds have been replaced by a host of kinetic impact projectiles in most parts of the world, birdshot—shotgun loads of small (<6 mm diameter) pellets—are still frequently deployed across the Middle East and South Asia as a crowd management strategy. Over the past decade, birdshot use in crowd control has been documented in Bahrain, Egypt, Iran, Iraq, Lebanon, Tunisia, and, most notably, India.

Birdshot is frequently deadly at close to medium ranges. The 2011 Bahraini uprising saw at least seven deaths directly attributed to police birdshot, with the majority of victims

being shot from a range no greater than five metres, often in the back.<sup>31</sup> Despite these deaths and hundreds of injuries attributed to these weapons, birdshot is still extensively deployed by Bahraini security officials, causing high numbers of deaths in 2012,<sup>32</sup> 2014,<sup>33</sup> 2015, and 2017.<sup>34</sup> In Egypt, Shaimaa al-Sabbagh, an Egyptian poet and activist, was killed after being shot in the back from close range with birdshot. More recently, birdshot from security forces killed protesters in Iraq in 2020<sup>35</sup> and in Sudan in 2022.<sup>36</sup>

By far the most sustained use of birdshot has been in the Indian Union Territory of Jammu and Kashmir, where police birdshot—fired from what are often mislabelled “non-lethal pellet guns” —has claimed the lives of at least 24 and injured thousands.<sup>37</sup> Our review of the scientific and medical literature regarding KIPs also identified eight studies about pellet injuries in Kashmir, which

31 “Report of the Bahrain Independent Commission of Inquiry,” (23 November 2011) accessible at: <http://files.bici.org.bh/BIClreportEN.pdf>.

32 W Al-Jawahiry and H Mohammed, “Bahrain protester died of birdshot wounds: relative,” *Reuters*, (23 April 2012), accessible at: <https://www.reuters.com/article/us-bahrain-protester/bahrain-protester-died-of-birdshot-wounds-relative-idUSBRE83M1BS20120423>.

33 Human Rights Watch, “Bahrain: Gunshot Deaths Require Swift Investigation,” *Human Rights Watch*, (11 June 2014), accessible at <https://www.hrw.org/news/2014/06/11/bahrain-gunshot-deaths-require-swift-investigation>.

34 Amnesty International, “Bahrain: At least one dead and hundreds injured as government violently cracks down on opposition,” *Amnesty International*, (23 May 2017), accessible at: <https://www.amnesty.org/en/latest/news/2017/05/bahrain-at-least-one-dead-and-hundreds-injured-as-government-violently-cracks-down-on-opposition/>.

35 Reuters Staff, “Iraqi security forces kill protester in Baghdad – police sources,” *Reuters*, (25 February 2020), accessible at: <https://www.reuters.com/article/uk-iraq-protests-violence-idINKBN20J2LR>.

36 AFP, “Sudanese protester killed as thousands march against coup,” *France 24*, (28 February 2022), accessible at: <https://www.france24.com/en/live-news/20220228-sudanese-protester-killed-as-thousands-march-against-coup>.

37 Business Standard, “Pellet guns have killed 24, blinded 139 in Kashmir since 2010: Report,” *Business Standard*, (2 August 2019), accessible at: [https://www.business-standard.com/article/current-affairs/pellet-guns-have-killed-24-blinded-139-in-kashmir-since-2010-report-119080200151\\_1.html](https://www.business-standard.com/article/current-affairs/pellet-guns-have-killed-24-blinded-139-in-kashmir-since-2010-report-119080200151_1.html).



recorded 1,669 individuals killed or injured by pellets—almost three times the number of KIP injuries previously recorded in literature published from 2017-2021. These injuries disproportionately resulted in permanent injury relative to other KIPs (see Figure 4).

Birdshot use is associated with a very high incidence of ocular injuries. In Kashmir, hundreds of civilians have suffered severe eye injuries as a result of the small-diameter, high-velocity shot, which disperses uncontrollably with increasing distance from the shooter.<sup>38</sup> This phenomenon is not unique to India; in one week of November 2012, Tunisian police's use of birdshot led to at least 20 cases of severe ocular trauma.<sup>39</sup> Ocular trauma stands out due to the often-permanent nature of the disability created, generating additional physical, mental, and

economic burdens for those maimed by these weapons.

Lead poisoning has also been reported due to the use of lead pellets, especially when they are embedded in the tissues of children and young people and not removed. Chronic exposure to even small doses of lead can lead to devastating physical and mental injuries. Lead is now known to produce a spectrum of injury across multiple body systems, affecting children's brain development and resulting in reduced intelligence quotient (IQ), behavioural changes such as reduced attention span and increased antisocial behaviour, and reduced educational attainment. Lead exposure also causes anaemia, hypertension, renal impairment, immunotoxicity, and toxicity to the reproductive organs. The neurological and behavioural effects of lead are irreversible.

---

38 See the case of Farzan Nazir Sheikh in INCLO, "Unhealed Wounds," accessible at: <https://www.inclo.net/projects/unhealed-wounds/>.

39 CL Belhadj, "A Decade After Cops Took Their Eyes, Siliana Victims Still Seek Justice," *Meshkal*, (30 December 2021), accessible at: <https://meshkal.org/a-decade-after-cops-took-their-eyes-siliana-victims-still-seek-justice/>.

## What has changed?

- › Increase in injuries: Since the publication of LiD1, the use of KIPs to suppress mass dissent has rapidly accelerated, with a corresponding increase in documentation of the resulting injuries. Of the 2,434 total injuries reported in the medical literature from 2016-2021, 2,232 were severe (92 per cent), a ratio higher than that found earlier (70 per cent). We note, however, that this proportion may be skewed by the under-reporting of less-severe injuries. At least 945 individuals (43 per cent) suffered permanent disability as a result of KIP injury, a ratio of maiming greater than that of the previous report (15 per cent). Ocular injuries also made up a much larger share of total reported injuries, with 1,575 cases (73 per cent) versus 310 cases (16 per cent) from the earlier literature. This total is due almost wholly to multi-projectile KIPs (1,511 cases, or 96 per cent).
- › Increase in use: Novel weapons have come to the fore over the last five years. In France, impact projectiles—notably a variety of KIPs commonly known as “flash-balls” —were widely used during the *gilets jaunes* protests of 2018-2020, resulting in life-threatening injuries to the face and eyes.<sup>40</sup> The Chilean

protests of October 2019 resulted in a wave of ocular injuries from “rubber buckshot.”<sup>41</sup> In the United States, the police response to protests in the wake of George Floyd’s murder saw extensive use of a wide variety of impact projectiles, resulting in a surge in potentially life-threatening injuries. In Colombia, the use of impact projectiles during the protests of the spring of 2021 resulted in more than one hundred ocular injuries.<sup>42</sup>

- › Multiple-projectiles: The widespread use of multi-projectiles (where multiple projectiles are fired at once) has allowed for a more in-depth analysis of these weapons in this report that demonstrates their particular harms. 82% (n=1994) of all injuries and deaths recorded in our updated literature review of KIPs were a result of multiple projectile rounds—KIPs that consist of more than a single missile fired at the same time (Figure 4). Furthermore, multiple projectile rounds were involved in a staggering 96% (n=1,511) of all ocular injuries from KIPs. Multiple projectiles are inherently indiscriminate: they cannot target a single individual or a single body part, resulting in excessive injury to targeted individuals (when they impact sensitive body parts) and to bystanders (when the projectiles spread to those not

40 R Lartzien et al., “Yellow vests protests: facial injuries from rubber bullets,” *The Lancet* 394, no. 10197 (2019): 469-470, doi:10.1016/S0140-6736(19)31764-7 and A Chauvin, et al., “Ocular injuries caused by less-lethal weapons in France,” *The Lancet* 394, no. 10209 (2019): 1616-1617, doi:10.1016/S0140-6736(19)31807-0.

41 A Rodríguez et al., “Ocular trauma by kinetic impact projectiles during civil unrest in Chile,” *Eye* 35 (2021): 1666-1672, doi:10.1038/s41433-020-01146-w.

42 O Griffin, “Over 100 Colombian protesters suffered eye damage by police in 2021 marches - report,” Reuters, 26 November 2021. Accessible at: <https://www.reuters.com/world/americas/over-100-colombia-protesters-suffered-eye-damage-by-police-2021-marches-report-2021-11-26/>

targeted. The results of our analysis suggest that these weapons are more dangerous than single projectiles, and restrictions on their use must be one of the first steps in limiting harm from KIPs.

- › 'Hybrid' weapons: The development and proliferation of novel 'hybrid' weapons that combine characteristics of KIPs with other less-lethal weapons add complexity to the assessment and treatment of injury from these weapons. Foremost among these are KIPs laced with chemical agents designed to deter through impact and chemical irritation concomitantly, most notably compressed-air weapons such as the "Pepperball" gun or the FN 303, which shoot irritant-filled spherical gelatine capsules. Stun grenades, also known as distraction devices, with a kinetic component—such as grenades designed to project rubber balls across their blast radii ("Stingball" grenades) along with a flash and report—are increasingly seen in protest settings, where they act in effect as indiscriminate KIPs.
- › Canisters misused as KIPs: Weapons not designed to function as impact projectiles are increasingly being pressed into service as improvised KIPs. Tear gas canisters, when fired directly at protesters, act as KIPs; however, they can be extraordinarily hazardous when used in this manner as they are dense, metallic, large and often heated or mid-explosion. These devices and their resultant injuries are reviewed in the chemical irritants section. Projectile-launched distraction devices, such as the Airborne Warning/Signalling Munition (AW/SM),<sup>43</sup> are designed to deflagrate 6 metres above the heads of crowds but have been directly fired towards individuals or crowds, risking serious injury and death.

---

43 Defense Technology, "40MM WARNING / SIGNALLING MUNITIONS; OC, CN, CS AND INERT MARKING; 50, 100, 200 AND 300 METERS," accessible at: [https://www.defense-technology.com/wp-content/uploads/2020/06/40mm-Warning\\_Signaling-Munition-w-Payload.pdf](https://www.defense-technology.com/wp-content/uploads/2020/06/40mm-Warning_Signaling-Munition-w-Payload.pdf).

## Case study

# Inherently inaccurate ‘double-ball rounds’ cause deaths and injuries of demonstrators and bystanders

## South Africa

Among the “less-lethal” weapons that the South African Police Service (SAPS) possess are the “double-ball rounds”, more commonly known by the generic name “rubber bullets”. They consist of double-ball rounds containing two hard rubber balls fired from a shotgun. Manufactured by a number of companies, around the world and in South Africa, the use of these inherently inaccurate weapons in policing protests and public gatherings have changed the lives of many people in South Africa, both through tragic deaths and injuries.

On 19 March 2018, Thembekile Fana, a 61-year-old man, died during a protest in the Eastern Cape after being shot by police.<sup>44</sup> According to a witness on the scene, Fana, who had been running for cover from police, stopped and raised his arms in surrender

before being lethally wounded by double-ball rounds fired from a police shotgun.<sup>45</sup> Fana’s son, Andile, noted that he saw 16 shell casings lying around his father’s lifeless body.<sup>46</sup> He further noted that Fana was shot under the arm—further evidence of his surrender<sup>47</sup> in the wake of impending death by CCW. Significantly, Fana was the only breadwinner in his family and was described as a community leader.<sup>48</sup> Research conducted in the wake of this tragedy found that the death of Thembekile Fana appears to have been linked to the use of double-ball rounds at close range.<sup>49</sup>

On 10 March 2021, Mthikozisi Ntumba, a 35-year-old civil servant, was shot and killed by police using double-ball rounds as he was leaving a medical clinic in Johannesburg city centre during protests.<sup>50</sup> Ntumba was leaving

44 D Bruce, “Rubber bullets well past their sell-by date”, Mail & Guardian. (6 December 2019), accessible at: <https://mg.co.za/article/2019-12-06-00-rubber-bullets-well-past-their-sell-by-date/>.

45 DispatchLive, “Protester ‘killed by cops’”, (20 March 2018) at: <https://www.dispatchlive.co.za/news/2018-03-20-protester-killed-by-cops/>.

46 *Id.*

47 Another prominent case of an individual shot while raising their arms and surrendering to law enforcement was the case of actor Patrick Shai who was shot eleven times in 2019, including in the neck, back, and arms by police using rubber bullets. Mr Shai had been seeking to intervene between police and protesters. See: <https://www.timeslive.co.za/news/south-africa/2019-11-11-actor-patrick-shai-shot-11-times-by-cops-during-soweto-protest-over-disconnected-electricity/>.

48 *Id.*

49 D Bruce, “Rubber bullets are high risk when used at close range”, Polity, (2019).

50 U Nkanjeni, “Mthokozisi Ntumba: Know the man who was killed in the Wits protest crossfire”, Times Live, (12 March 2021), available at: <https://www.timeslive.co.za/news/south-africa/2021-03-12-mthokozisi-ntumba-know-the-man-who-was-killed-in-the-wits-protest-crossfire/>.



STUDENT SPEAKS DURING THE DEMONSTRATION. SOUTH AFRICAN POLICE MOVED TO DISPERSE STUDENTS PROTESTING AGAINST REFUSAL BY WITS UNIVERSITY TO REGISTER THOSE STUDENTS IN ARREARS WITH TUITION FEES. POLICE CLASHED WITH PROTESTERS WHO WERE BLOCKING THE ROADS WITH RUBBLE AND DISRUPTING TRAFFIC IN JOHANNESBURG. POLICE VIOLENTLY REPPRESSED THIS STUDENT PROTEST AT WITS UNIVERSITY IN JOHANNESBURG WITH DOUBLE BALL ROUNDS, FATALLY SHOOTING PASSERBY MTHOKOZISI NTUMBA. THABO JAIYESIMI | SOPA IMAGES/SIPA USA/AP IMAGES

his doctor's rooms, when he caught himself in the crossfire of running protests over historical debt between police and students.<sup>51</sup> It was also reported that three students, who were waiting outside the Johannesburg Institute of Engineering and Technology College, were also shot and injured by police using double-ball rounds that day.<sup>52</sup> According to a CCTV video of the alleged incident, police violently pursued a group of people standing on a

sidewalk and can be clearly seen firing their shotguns indiscriminately as people flee for safety.<sup>53</sup> Four Johannesburg Metropolitan Police Department (JMPD) officers were subsequently arrested and charged with one count of murder and three counts of attempted murder.<sup>54</sup> An investigating officer with the Independent Police Investigative Directorate reported that she found "Ntumba's body with wounds on the left side of his chest, under

51 B Wicks, "SERI wants answers after acquittal of cops accused of Mthokozisi Ntumba's murder" Eyewitness News, (8 July 2022), accessible at: <https://ewn.co.za/0001/01/01/seri-wants-answers-after-acquittal-of-cops-accused-of-mthokozisi-ntumba-s-murder>.

52 J Chabalala, "Cops accused of killing Mthokozisi Ntumba amid student protest want case thrown out", News24. (4 July 2022), accessible at: <https://www.news24.com/news24/southafrica/news/cops-accused-of-killing-mthokozisi-ntumba-amid-student-protest-want-case-thrown-out-20220704>.

53 SERI, "The excessive use of force: We demand accountability for Mthokozisi Ntumba", (7 July 2022), accessible at: <http://www.seri-sa.org/index.php/latest-news/1235-press-statement-the-excessive-use-of-force-we-demand-accountability-for-mthokozisi-ntumba-7-july-2022>.

54 See above 50.



his armpit and under his left eye”.<sup>55</sup> During Ntumba’s postmortem, a ballistics expert “confirmed that the deceased was shot by a rubber bullet at close range”.<sup>56</sup> Ntumba’s case is not the only recent case of the tragic death of a bystander: In 2017, in Bela-Bela, Karabo Kuhmalo, an 11-year old boy, died after being hit in the head by rubber bullets fired by the South African police.<sup>57</sup>

Siphesihle Mtsweni, 21, then a student at the Johannesburg Institute of Engineering and Technology was also shot by police using double-ball rounds during the protest that day. Mtsweni, who sustained injuries from the double-bullet rounds to the face, said he dropped out of college later that year due to trauma following the shooting incident.<sup>58</sup> “When I would go back to the college, I was reminded of what happened when I was shot. I am reminded of the dead body I saw,” said Mtsweni.<sup>59</sup>

Double-ball rounds are a particularly dangerous type of kinetic impact projectile.

Owing to their design, cartridges that contain multiple projectiles are inaccurate. Once fired, the projectiles separate, and can rapidly disperse, resulting in unpredictable impacts. This inaccuracy only increases over longer distances. As a result of this design, projectiles from double-ball rounds may impact unintended parts of the body, including the head, face or neck, which could cause serious injury. Despite their inherently inaccurate nature, the use of different types of rubber bullets continues to be a key part of police responses to protests and other public gatherings in South Africa. This tendency to rely on less-lethal weapons and equipment for public order policing was addressed in the Panel of Experts Report on Crowd Management, published following the Marikana Commission of Inquiry<sup>60</sup> (a case included in LiD1) although the recommendations of that Report have not been prioritised.

---

55 C Mahamba, “Mthokozisi Ntumba shot at close range with rubber bullets, court told”, The Star. (25 March 2021), accessible at: <https://www.iol.co.za/the-star/news/mthokozisi-ntumba-shot-at-close-range-with-rubber-bullets-court-told-cd1ba027-d380-4707-b0f0-2d90561cbb7a>.

56 *Id.*

57 See above n 43 and J Bornman, “Family angry over death of 10-year-old boy allegedly shot by police in BelaBela”, Times Live, 9 February 2017, accessible: <https://www.timeslive.co.za/news/south-africa/2017-02-09-family-angry-over-death-of-10-year-old-boy-allegedly-shot-by-police-in-bela-bela/>.

58 M Koka, “Former student testifies about being shot on day Mthokozisi Ntumba was killed”, Sowetan Live. (10 February 2022), accessible at: <https://www.sowetanlive.co.za/news/south-africa/2022-02-10-former-student-testifies-about-being-shot-on-day-mthokozisi-ntumba-was-killed/>.

59 *Id.*

60 Panel of Experts Report on Policing and Crowd Management, Established by the Minister of Police in Terms of the Recommendations of the Marikana Commission of Inquiry, Final Report, (27 May 2018).

## Sidebar

## Manufacture and procurement of double-ball rounds

Double- and triple ball rounds are manufactured and procured by a wide range of companies. Many of the double-ball rounds used in South Africa are manufactured in South Africa, but there are companies manufacturing double- and triple-ball rounds across the world. Among these are believed to be: the Spanish company, Trust Eibarres SA, manufactures both double- and tripleball rounds for law enforcement;<sup>61</sup> the Turkish company, ZSR;<sup>62</sup> the Czech company, Sellier & Bellot;<sup>63</sup> the Brazilian company, Condor;<sup>64</sup> and the US-based company, Defense Technology, makes a 'Multiple Rubber Baton Round' with three projectiles.<sup>65</sup>

Several companies within South Africa manufacture a range of kinetic impact projectiles – including the double-ball round. The most notable historical South African manufacturer of kinetic impact projectiles

was Swartklip Products, which became a Denel (now Rheinmetall Denel) subsidiary during the 1990s. In 2014, the then-Chief Executive of Rheinmetall Denel Munition, Norbert Schulze, was confident that “locally produced rubber bullets, flash-bangs and tear gas [would soon be] used by police”.<sup>66</sup> Another manufacturer is Industrial Cartridge, that currently markets ‘2 ball baton’ and ‘3 ball baton’ 12-gauge ammunition among its ‘Law Enforcement Shotshells’ range<sup>67</sup> and that reported to have seen “high demand for less lethal ammunition for crowd control, with orders from South African entities taking up much of its production capacity” in 2019.<sup>68</sup> That same year, the South African Police Service published a tender to supply “shotgun, 12 gauge/bore baton double ball, soft silicone, smokeless propellant, orange to the South African Police Service: nationally for a period of three (3) years.”<sup>69</sup> In July 2020,

61 Trust Eibarres SA, “Law Enforcement”, available at: <https://www.cartuchostrust.com/en/cartridges/law-enforcement/>.

62 ZSR Patlayıcı Sanayi A.Ş, “Traumatic”, accessed at <https://zsrpatlayici.com/traumatic-en>.

63 Sellier & Bellot, “Law enforcement products: 12/67.5 rubber ball”, accessible at: <https://www.sellier-bellot.cz/en/products/law-enforcement-products/12-67-5-rubber-ball/list/>.

64 Condor Tecnologias Nãa-Letais, “AM-403/A TRIMPACT – TRÊS PROJÉTIS DE BORRACHA”, accessible at: <https://www.condornaletal.com.br/am-403-a/?lang=en>.

65 Defense Technology, “Multiple Rubber Baton Round 40mm”, accessible at: <https://www.defense-technology.com/product/multiple-rubber-baton-round-40mm/>.

66 K Helfrich, “Exports essential for Rheinmetall Denel Munition”, (4 February 2014), accessible at: <https://www.defenceweb.co.za/industry/industry-industry/exports-essential-for-rheinmetall-denel-munition/>

67 Industrial Cartridge SA, Less Lethal Ammunition – 12 Gauge. Law Enforcement Shotshells, accessible at: <https://industrialcartridgesa.com/less-lethal-ammunition/>.

68 defenceWeb, “High demand for less lethal rounds”, (6 December 2019), accessible at: <https://www.defenceweb.co.za/featured/high-demand-for-less-lethal-rounds/>.

69 Awarded Bid. Bid Number 19/1/9/1/03TT(19), accessible at: <https://www.saps.gov.za/services/bidthumbnail.php?id=2679>.



BANGKOK, THAILAND - MARCH 20, 2021: RIOT POLICE FIRE RUBBER BULLETS TO PRO-DEMOCRACY PROTESTERS DURING A CRACKDOWN AT SANAM LUANG AND RATCHADAMNOEN NAI RD. DIRACH TOUMLAMOON | SHUTTERSTOCK

the successful bidder, IT Empowerment Technologies, was awarded a three-year R30.5 million contract. Although the contract between the SAPS and IT Empowerment Technologies was cancelled later in 2020,<sup>70</sup> it is unclear if the tender was re-issued or if a previous supplier has been contracted instead of IT Empowerment Technologies.

Civil society actors in South Africa have repeatedly criticised the nature of the use of these kinetic impact projectiles within South Africa.<sup>71</sup> Despite this, police forces continue to procure new stocks of double-ball rounds. The lack of transparency and clear global

standards regarding the manufacture of these weapons around the world, their testing before purchase by governments and their procurement<sup>72</sup> creates immense challenges for organizations seeking to monitor abuses related to these weapons and the fight for justice by victims and their families.

70 defenceWeb, "Inflated' SAPS rubber bullet tender cancelled", (23 September 2020), accessible at: <https://www.defenceweb.co.za/land/land-land/inflated-saps-rubber-bullet-tender-cancelled/>.

71 See, for example, M Rayner, L Baldwin-Ragaven, with S Naidoo, "A Double Harm: Police misuse of force and barriers to necessary Health Care Services", Socio-Economic Rights Institute of South Africa and D Bruce, "Rubber bullets are high risk when used at close range", ISS Today (28 November 2018), accessible at: <https://issafrica.org/iss-today/rubber-bullets-are-high-risk-when-used-at-close-range>.

72 In the case of the IT Empowerment Technologies' successful bid, it was alleged that the SAPS "*paid five times what they should have for less lethal ammunition*" and a whistleblower, Colonel (ret.) David Peddle, alleged that "the ammunition was not tested to the latest SAPS specifications before the bid was approved". See defenceWeb, "Concern over 'inflated' SAPS rubber bullet tender", (2 September 2020), accessible at: <https://www.defenceweb.co.za/industry/industry-industry/concern-over-inflated-saps-rubber-bullet-tender/>.

## Case study

## Man killed by ESMAD with bean bag shot

### Colombia

On 21 November 2019, a series of social demonstrations in Colombia was called by unions, students, pensioners' associations, and other groups in response to several factors, including proposed modifications to the pension, labour, and tax regime; non-compliance with the peace agreements; the murders of human rights defenders; and socioeconomic inequalities.

On 23 November 2019, Dilan Cruz, an 18-year-old, was participating in demonstrations in the centre of Bogota, the country's capital. ESMAD (*Escuadrón Móvil Antidisturbios*), the police unit responsible for crowd and riot management, began to throw tear gas and stun grenades to disperse the demonstrators. In videos, Cruz can be seen picking up a grenade, throwing it back at the agents and, within seconds, being hit in the back of the head by a flying object. The projectile that hit him was a bean bag, fired by Captain Manuel Cubillos Rodríguez from a 12-gauge shotgun, which is one of the less lethal weapons authorised for police use under Colombian law.

Dilan Cruz died two days after the incident, while in intensive care.<sup>73</sup> The National

Institute of Legal Medicine and Forensic Sciences confirmed in his autopsy that the cause of death was "secondary to penetrating cranioencephalic trauma, caused by low impact ammunition, which causes severe and irreversible damage to the brain."<sup>74</sup> That is to say, he was killed by the impact of the bean bag ammunition, which complied with the manufacturer's technical data sheet and had not been modified. His death fuelled further protests, including demands for the end of police violence and the end of impunity for deadly police conduct.

Cruz's death was followed by almost two years of disagreement regarding whether the ordinary justice system or the military criminal justice system had the authority to investigate and criminally prosecute the ESMAD agent. The Constitutional Court, the highest court in Colombia on constitutional matters, ruled that the investigation should continue in the ordinary justice system. In December 2021, the agent was required to attend a disciplinary trial by the *Procuraduría General de la Nación* (the national prosecutor's office), which is in charge of investigating and sanctioning public officials for actions taken in their official capacity.<sup>75</sup> According

73 D Cruz, Colombian teenager injured by police projectile, dies, BBC News, (26 November 2019), accessible at: <https://www.bbc.co.uk/news/world-latin-america-50557496>.

74 Medicina Legal confirmó que Dylan murió por disparo del ESMAD. El Tiempo, (28 November 2019), accessible at <https://www.eltiempo.com/justicia/investigacion/dylan-cruz-medicina-legal-confirio-que-el-joven-murio-por-el-disparo-del-esmad-438524>.

75 Capitán del ESMAD fue citado a juicio disciplinario por muerte de Dylan Cruz, Revista Semana, (10 December 2021), accessible at: <https://www.semana.com/nacion/articulo/capitan-del-esmad-fue-citado-a-juicio-disciplinario-por-muerte-de-dylan-cruz/202115/>.





THE MOTHER OF DILAN CRUZ WHO WAS KILLED BY THE POLICE IN A BOGOTÁ PROTEST SHOWS A PICTURE OF HIM IN DURING THE COLOMBIAN NATIONAL STRIKE AGAINST THE IVAN DUQUE GOVERNMENT. BOGOTÁ, COLOMBIA. 19 MAY, 2021. SEBASTIAN DELGADO C. | SHUTTERSTOCK

to the prosecutor's office, "The investigated officer did not take the necessary care when activating the shotgun he was carrying, since regardless of whether the weapon is listed among the least lethal weapons, it will always affect the integrity of the people."<sup>76</sup> Despite this finding, to date there has been no decision on the merits of the case.

In December 2019, days after Cruz's death, civil society organisations and concerned individuals filed a legal action seeking protection of the fundamental right to protest. In September 2020, the Supreme Court of Justice finally issued a ruling<sup>77</sup> protecting the right of all persons to protest and clarifying the duty of authorities to "avoid, prevent and sanction the systematic, violent and

arbitrary intervention of the public forces in demonstrations and protests." The court's ruling suspended the use of 12-gauge shotguns, the weapon used to shoot the bean bags, by ESMAD. The suspension continues to this day, and the Ombudsman's Office of Colombia is obliged to monitor compliance with this order.

76 Procuraduría General de la Nación, Procuraduría formuló cargos a capitán de la Policía Nacional por la muerte de Dilan Cruz, (10 December 2021), accessible at: <https://www.procuraduria.gov.co/portal/PROCURADURIA-FORMULO-CARGOS-A-CAPITAN-DE-LA-POLICIA-NACIONAL-POR-LA-MUERTE-DE-DILAN-CRUZ.news>

77 See <https://www.dejusticia.org/en/supreme-court-of-justice-protects-the-right-to-protest-against-police-violence/>.



## Case study

## Expanding bullets among multiple CCWs used in Minsk demonstrations

### Belarus

On 9 August 2020,<sup>78</sup> after the results of Belarus's presidential election were announced, mass protests broke out to denounce what many Belarusians - and international observers - saw as an unfair, rigged election. Aliaksandr,<sup>79</sup> a 37-year-old driver, joined other protesters seeking to gather in the centre of Minsk. He was among approximately 20 people who, trying to make their way to the main protest site, approached a police van and a group of policemen. When Aliaksandr's group was approximately 15 metres from the police van, at least three rounds of ammunition were fired, and Aliaksandr was struck in the abdomen. He tried to run away but managed to stumble only 150 metres before being picked up by strangers and taken to a hospital by car.

Aliaksandr was operated on, and the surgeon later told him that a rubber bullet had been extracted from his body. According to the surgeon, the bullet was made of plastic, but its core was made of small metal balls, which expanded on impact and were easily visible in an X-ray image. Aliaksandr was in

severe pain for many days. He spent 15 days in intensive care and had to undergo further operations abroad, as the treatment available in Belarus was limited and expensive. It took him five months to recover.

Hundreds of thousands of Belarusians protested over several weeks after the elections, and these demonstrations were regularly dispersed violently, using CCWs such as rubber bullets, tear gas, and stun grenades. It is estimated that hundreds of protesters were severely injured, and at least 15 protesters died during the 2020 protests.<sup>80</sup> *Mediazona*, an independent media outlet, reported the number of arrests at over 33,000<sup>81</sup> and *Viasna*, a major human rights group, counts over 1,300 of those as political prisoners. Hundreds have been reportedly beaten and tortured in custody.<sup>82</sup>

A report by the UN Office of the High Commissioner for Human Rights (OHCHR), published on 5 March 2022, detailed excessive and inappropriate uses by Belarusian security forces of batons, water cannons, tear

78 This is a summary of the incident reported at <https://august2020.info/ru/detail-page/292>.

79 Republic of Belarus has two official languages, Belarusian and Russian. For the sake of consistency, the transliterations follow the Belarusian versions of names, even where sources are in Russian.

80 FIDH, "Supplying the means for repression in Belarus," December 2021. Accessible at: [https://www.fidh.org/IMG/pdf/548344402-supplying-the-means-for-repression-in-belarus\\_1\\_.pdf](https://www.fidh.org/IMG/pdf/548344402-supplying-the-means-for-repression-in-belarus_1_.pdf).

81 See <http://mediazona.by/number/2022/08/22/detained>.

82 Human Rights Watch, "Belarus: Systematic Beatings, Torture of Protesters," *Human Rights Watch* (15 September 2020), <https://www.hrw.org/news/2020/09/15/belarus-systematic-beatings-torture-protesters>.



A WOMAN ON HER KNEES STANDS IN FRONT OF THE RIOT POLICE IN A PUBLIC UNREST STARTED IN THE STREETS OF MINSK, BELARUS, ON AUGUST 9, 2020 AT THE END OF THE VOTING DAY WITH PEOPLE CLAIMING FOR A GOVERNMENT CHANGE AND PROTESTING BECAUSE FRAUD ELECTIONS FOR THE PRESIDENCY OF BELARUS. CELESTINO ARCE | NURPHOTO VIA GETTY IMAGES

gas, and kinetic impact projectiles, including rubber-coated steel bullets. The UN report stated, “On the basis of an analysis of 26 first-hand witness accounts, their medical records and photographic material, in conjunction with a review of the injuries of more than 1,000 individuals treated by the Minsk medical emergency services during the protests, along with open source material, OHCHR found that injuries resulting from the use of force in several cities across Belarus between 9-12 August included tramline bruises and hematomas on the torso, buttocks, and back of the legs, head injuries (such as brain contusion), concussion, traumatic wounds, fractures and burns, ear drum perforations as a result of acoustic trauma, and eye injuries. More severe injuries included multiple organ injuries sustained from rubber-coated steel bullets and internal organ damage caused by shrapnel from stun grenade fragments and burns caused by explosions.”<sup>83</sup>

Not only has Belarus failed to investigate these actions of security forces, but some of the civilians who complained were themselves prosecuted. According to authorities, a complaint about police brutality was an admission of “participation in mass disorder.” A report from the human rights group FIDH<sup>84</sup> highlighted the issue of the unregulated transfer of CCWs from the European Union (EU) to Belarus. After the crackdown on the protests in Minsk and other cities, journalists found KIP ammunition produced in Turkey (STERLING 12 gauge less lethal cartridge with rubber bullet), Latvia (D Dupleks 12/70 cartridge with rubber bullet), and Poland (Fam-Pionki 12/70 light and sound cartridge ONS 2000).<sup>85</sup> Multiple testimonies were collected by human rights activists and journalists about police use of CCWs. It is a striking commonality in many of these testimonies that the police used CCWs not when the protests were at their largest, but at times when the demonstrators barely started gathering or were dispersing. It may reasonably be inferred that CCWs were used not in self-defence, but to frighten and punish the protesters.

83 OHCHR, “High Commissioner’s report on the situation of human rights in Belarus in the run-up to the 2020 presidential election and in its aftermath, A/HRC/49/71, paras 25-30” 4 March 2022. Accessible at: <https://www.ohchr.org/en/hr-bodies/hrc/ohchr-belarus/index>

84 FIDH, “Supplying the means for repression in Belarus,” December 2021. Accessible at: [https://www.fidh.org/IMG/pdf/548344402-supplying-the-means-for-repression-in-belarus\\_1\\_.pdf](https://www.fidh.org/IMG/pdf/548344402-supplying-the-means-for-repression-in-belarus_1_.pdf).

85 *Id* at p 18



# CHEMICAL IRRITANTS

06 APRIL 2018, PALESTINIAN TERRITORIES, KHAN YUNIS: PALESTINIAN PROTESTERS RUN FOR COVER WHEN ISRAELI SOLDIERS BOMB THEM WITH TEAR GAS. 2 PALESTINIANS HAVE BEEN KILLED AND 250 INJURED SINCE THE MASSIVE PROTESTS STARTED LAST FRIDAY. A SPEAKER OF THE PALESTINIAN HEALTH SERVICE TOLD THE PRESS THAT MORE PEOPLE HAVE BEEN CRITICALLY WOUNDED. MOHAMMED TALATENE | PICTURE ALLIANCE/DPA/AP IMAGES

## Weapon profile

Chemical irritants include a variety of chemical compounds intended to produce sensory irritation and pain. Conventionally referred to as “tear gas” or “riot control agents,” chemical irritants come in a variety of formulations, sizes, concentrations, and delivery mechanisms, depending on the manufacturer and the context for which they are intended. Historically categorised as non-lethal or less lethal, the general perception is that the weapon does not cause permanent injury or death but instead has mostly short-term effects such as transient lacrimation (flowing of tears), ocular irritation and pain, blepharospasm (eyelid spasm), dermal pain, respiratory distress, and transient psychological effects of disorientation and agitation.<sup>86</sup> This perception is now being challenged, with more evidence of associated

longer-term and even permanent injuries as well as deaths.

Chemical irritants include a wide range of agents that have been developed and deployed for many decades, in addition to ones that are currently under development. There are four chemical compounds that have been most frequently cited in purchase orders, reports, and studies in the past three decades: chlorobenzalmalonitrile (agent CS), chloroacetophenone (agent CN), oleoresin capsicum (agent OC, known as pepper spray), and OC’s synthetic form, PAVA. Of these four, the two most commonly used by law enforcement agencies in recent years for crowd control are agents CS and OC.

Lacrimator (tear-producing) agents are older and still frequently used across the globe. They act on TRPA1 receptors that are

---

86 MM Stark, “CS Spray,” *Journal of Accident & Emergency Medicine* 15, no. 4 (July 1998): 288.

located on the plasma membranes of many human cells and are sensors for pain, cold, itch, and for environmental irritants to initiate protective responses such as tears, airway resistance, and cough. Of the lacrimator agents, agent CS is the most commonly used. It was developed in the 1920s in the United States and was introduced as a weapon by the US military to replace agent CN in the 1950s.<sup>87</sup> Agent CS then became a frequently used military weapon in the second half of the twentieth century and was famously deployed by the U.S. military in the Vietnam War.<sup>88</sup> Military use is now banned, but agent CS is now widely used by law enforcement agencies in many countries – often as the weapon of choice in the context of protest and civilian crowd management. While the US is still the largest manufacturer of CS, many other countries have developed the industry, among them Brazil, South Korea, India, Israel and France. Despite the United States remaining the biggest producer of CS, the US Environmental Protection Agency (EPA) has not set a minimum threshold of concentration at which the general population could experience “notable discomfort, irritation, or certain asymptomatic, non-sensory but transient effects,”<sup>89</sup> because even the lowest concentrations cause these symptoms. The volume of chemicals in each spray and gas

varies considerably among manufacturers and countries.<sup>90</sup>

Agent OC, the second most-commonly cited capsaicin agent, is essentially a highly concentrated form of hot pepper and acts as an agonist on TRPV1 pain receptors, causing a burning sensation from stimulation of the nerve. Agent OC and its synthetic form, PAVA, have recently increased in popularity as potent and effective crowd-control agents. Also developed by the United States and originally used as a deterrent against wild animals (and by the U.S. Postal Service against dogs), OC was developed in the late 1970s and became a law enforcement weapon in the late 1980s.<sup>91</sup> It is now available both as a spray and in gas form, with lower concentrations being available as a self-defence “pepper spray” for the public. More potent variants are developed for military and law enforcement agencies. These have increasingly become weapons of choice for crowd control. The potency of these weapons depends both on the concentration of OC within the solvent and the strength of the “capsicum” – the active chemical that makes pepper spicy. It is worth noting that OC may also potentially include toxic chemicals, such as alcohol, halogenated hydrocarbons, and propellants, such as Freon.

87 BB Corson and RW Stoughton, “Reactions of Alpha, Beta-Unsaturated Dinitriles,” *Journal of the American Chemical Society* 50, no. 10 (1 October 1928): 2825–37, doi:10.1021/ja01397a037; M Lenhart, ed., *Medical Aspects of Chemical Warfare* (Office of the Surgeon General, Department of the Army, United States of America, 2008), chap. 13.

88 EJ Olajos and H Salem, “Riot Control Agents: Pharmacology, Toxicology, Biochemistry and Chemistry,” *Journal of Applied Toxicology: JAT* 21, no. 5 (October 2001): 355–91.

89 B Ballantyne and S Callaway, “Inhalation Toxicology and Pathology of Animals Exposed to O-Chlorobenzylidene Malononitrile (CS),” *Medicine, Science, and the Law* 12, no. 1 (January 1972): 43–65.

90 “Acute Exposure Guidelines Levels (AEGs) for Tear Gas (CS)” (National Advisory Committee for Acute Exposure Guideline Levels for Hazardous Substances, September 2009), accessible at: [http://www.epa.gov/oppt/aegl/pubs/tear\\_gas\\_interim\\_sept\\_09\\_v1.pdf](http://www.epa.gov/oppt/aegl/pubs/tear_gas_interim_sept_09_v1.pdf).

91 Lenhart, *Medical Aspects of Chemical Warfare*, chap. 13.



Chloroacetophenone (CN), chloropicrin (PS), bromobenzylcyanide (CA), dibenzoxazepine (CR), and combinations of these chemicals—also classified as lacrimator agents, riot control or “tear gas”—function similarly, albeit with myriad toxicity and potency profiles. Agent CN, the oldest among them and the active ingredient in “Mace,” is used by the military and law enforcement and is also available to the general public in many countries for personal protection or animal protection sprays. It has been less commonly used in public policing since the advent of CS because it is more potent and less toxic. Chloropicrin (PS), best known as an agricultural fumigant, was developed as a chemical warfare agent (military designation, PS). It was used in large quantities during World War I and was stockpiled during World War II. Agent PS is known to have a strong irritating smell and can cause extended lung, gastrointestinal and neurological injury at high doses. Dibenzoxazepine (CR); was developed by the British military in the 1950s and 60s. Six to ten times stronger than Agent CS, CR has been frequently called “firegas”. Agent CR is less toxic than Agent CS at comparable doses, but it can be lethal in high doses or poorly ventilated spaces, even in short time spans and tight spaces; It is also known as a carcinogen and can persist on porous surfaces for weeks. Significantly, CR was used in Northern Ireland and Vietnam in military operations.

In policing, reports suggest it has been used by Turkish and Ukrainian police during

protests and, more recently, in Egypt and France. CS1 and CS2 are newer versions of CS: they reduce degradation and extend the shelf life of CS or, in the case of CS2, increase weather resistance and flow into the respiratory system by microencapsulating the CS in silicone. Other lacrimator agents include Bromobenzyl cyanide (CA) and bromoacetone (BA). These are older, highly toxic lacrimators that have not been used in recent decades. Diphenylchlorarsine (DA), diphenylaminearsine chloride (Adamsite (DM)) and diphenylcyanarsine (DC) are known as vomiting agents and may be used in combination with lacrimators in some contexts.

Riot-control agents are banned by the 1997 Chemical Weapons Convention (CWC) for military use or as “a method of warfare.” Discussions at the time reflected concerns about the indiscriminate nature of the weapons, the possibility of escalation, the uncertainty around the use of CCWs versus lethal chemical agents, and the unnecessary suffering they cause.<sup>92</sup> Despite this ban, there continues to be military use of riot control agents, albeit with caveats. For example, although the United States signed and ratified the CWC, it has reserved the right to use riot-control agents in certain situations, including counter-terrorist and hostage-rescue operations, as well as military operations against non-state actors initiating armed conflict. And while military use of chemical irritants is limited, the CWC does *not* restrict or regulate its use by domestic

---

92 Chemical Weapons Convention below n 333; and International Committee of the Red Cross, “Practice Relating to Rule 75. Riot Control Agents,” *Customary IHL Database* (2005), Cambridge University Press, Cambridge, accessible at: [https://ihl-databases.icrc.org/customary-ihl/eng/docs/v2\\_rul\\_rule75](https://ihl-databases.icrc.org/customary-ihl/eng/docs/v2_rul_rule75).



law enforcement in civilian contexts. Several countries have limitations<sup>93</sup> on the possession and use of OC and CS, in either spray or gas form, but they are wholly unregulated in most countries.<sup>94</sup>

## Mechanism of action

Chemical irritants are utilised for crowd dispersal or for individual control or incapacitation by causing pain and sensory irritation. Commonly used lacrimator agents are synthetic organic halogen compounds that are potent triggers of the TRPA1 pain receptors present on the skin and mucous membranes (eyes, nose, mouth, respiratory tract) and cause pain, irritation, tearing, sensations of heat, cold, and itching (pruritis), and a host of involuntary reactions such as eyelid spasm (blepharospasm) and coughing. CS and CN have been found to be 10,000 times more potent than naturally found agonists of these receptors (such as mustard, garlic, very high temperatures and low pH compounds). CR is known to be twice as potent as Agent CS. Oleoresin capsicum (OC) and PAVA, the synthetic and more highly concentrated form of OC, produce similar effects compared to the lacrimator agents and are also common pathways of inflammation, resulting in more generalised sensations of inflammation and pain.

CS and other gases can be released into the air as fine particulate smoke, vapour or liquid spray (aerosol). They can also contaminate water and

food. They are typically deployed in two ways: in the form of a spray or as a canister/grenade in crowd-control settings. However, mechanisms of delivery vary. These include pellets and pepper balls, used in targeting individuals, as well as water cannons, which, along with grenades and canisters, provide more indiscriminate means of crowd control. Pellets can be designed for a “pepper spray gun”, which uses a compressed gas cartridge capable of firing 21 rounds. Per the manufacturers, the rounds travel at 320 feet per second, with an effective range of over 150 feet and release a 4–5-foot cloud of smoke when they explode.<sup>95</sup> Newer forms include plastic balls filled with chemical irritants that act as a combination of plastic bullet and gas weapon.

The spray variant for CS, OS, and other gases is usually available in the form of an enclosed unit under pressure and is released as a fine spray by means of a propellant gas. These aerosolised forms of chemical irritants are typically released from 0.3 to 3 metres from the target, and the spray pattern can be variable depending on the design of the weapon, the pressure of the spray mechanism, and wind conditions. Powder forms of chemical irritants are contained in canisters or grenades and typically are triggered to conduct a thermal explosion and disperse widely in the surrounding area.

Chemical irritants are indiscriminate weapons by design, especially when delivered by firing a grenade or a canister. Limiting the exposure to individuals or small groups is virtually impossible, and the risk of affecting bystanders

---

93 Limitations vary by country. Some countries have limitations on use by law enforcement, especially regarding concentration, amount of volume carried, etc. Many other countries have limitations on possession/use by the general population.

94 Medical News Today, “What Is Pepper Spray? Is Pepper Spray Dangerous?” *Medical News Today*, (25 November 2011, accessible at: <http://www.medicalnewstoday.com/articles/238262.php>).

95 SALT Supply Co., “s1 Pepper Spray Gun Starter Kit,” accessible at: <https://www.saltsupply.com/collections/pepper-spray-gun/products/s1-pepper-spray-gun-starter-kit>.

and individuals other than the intended targets is high. In addition, the diagnosis and treatment of chemical irritant exposure is complicated because of the combination of different chemicals and the lack of transparency about the agents used.

Agent CS, the most commonly used chemical irritant, is not actually a gas but rather a powder at room temperature that is aerosolized by a triggered thermal explosion and disperses widely from a canister. A gas canister is estimated to have between 80 and 120 grams of CS, usually in concentrations between 0.1 and 10 per cent, but much higher concentrations are also commercially available.<sup>96</sup> The concentration of CS, however, can be significantly increased by the firing of multiple canisters in the same location. This practice often occurs in crowd-control situations and further complicates the analysis of the toxicity of the chemical as actually used.

To accurately understand the effect of exposure to CS, a measurement of density or concentration (milligrams per cubic metre) for exposure time is necessary. Based on animal and human models, it is estimated that exposure to agent CS at a concentration of 140 mg/m<sup>3</sup> for 10 minutes or 11 mg/m<sup>3</sup> for one hour, or as little as 1.5 mg/m<sup>3</sup> for four to eight hours, can be lethal.<sup>97</sup> Individuals exposed to high concentrations in closed spaces or for extended amounts of time, for instance, can suffer serious health

consequences and even death. When used outside, a CS grenade or canister produces a cloud of chemicals, usually within 60 seconds, with the highest CS concentration of 2,000 to 5,000 mg/m<sup>3</sup> detected at the centre of the cloud. Because of the nature of the weapon, it is difficult to measure these concentrations in practical situations of deployment or to have accurate estimates in retrospect.

Agent OC, most commonly found in spray form, is available in different concentrations from 1 to 10 per cent of capsaicinoids as oil in a solvent. Studies suggest that even very low (0.003 mg/m<sup>3</sup>) concentrations can lead to ocular irritation.<sup>98</sup> Because of the complexities in measuring concentrations of agent OC, lethal dose levels are difficult to verify.

To our knowledge, there are no known biomarkers that can be used to determine the presence of any chemical irritants in biological systems. Some on-scene testing for air samples can only be conducted by government bodies, and this testing only determines whether chemical irritants are present or absent. No additional testing is currently in place for environmental samples (e.g., filters, swabs, or wipes).<sup>99</sup>

---

96 "Combined Systems Inc, "Company site, *CSI Inc. Supporting Military Forces and Law Enforcement Agencies World-Wide*, (24 April 2015), accessible at: <https://www.combinedsystems.com/products/?cid=13>.

97 National Advisory Committee for Acute Exposure Guideline Levels for Hazardous Substances, "Acute Exposure Guidelines Levels (AEGs) for Tear Gas (CS)."

98 RC Gupta, *Handbook of Toxicology of Chemical Warfare Agents* (Academic Press, 2015).

99 United States Environmental Protection Agency, "Selected Analytical Methods for Environmental Remediation and Recovery (SAM)," accessible at: <https://www.epa.gov/esam/selected-analytical-methods-environmental-remediation-and-recovery-sam>.

Type	Name	Characteristics and properties	Duration of action	ID50 and LD50 (mg/ min per m3) – Incapacitating Dose and Lethal Dose**	Treatment Considerations	Environmental Considerations	Other information
Lacrimator Agents  Act on TRPA 1 pain receptors	Agent CN	Apple odour; white powder or emulsion; insoluble in water	10 – 20 minutes	20-50  8,500 – 25,000	Fresh air typically effective in decontamination	Powder at room temp, degrades quickly on surfaces	Historically in riot control, now primarily in sprays (MACE)
	Agent CS	Yellow solid or powder, pepper odour; soluble in water	10 – 30 minutes	4-20  25,000 – 100,000	Water and fresh air commonly used, Alkaloids known to be a lay treatment	CS degrades in hours on surfaces, CS1 and CS2 can last on surfaces and skin for longer times	Most commonly used in riot control canisters globally
Capsaicin Agents  Act on TRPV1 pain receptors	Agent CR	Pale yellow solid or powder, pepper odour, known as “firegas”, very soluble in water	10 minutes to 48 hours	unknown	Use of water may exacerbate CR pain and inflammation up to 48 hours	Can last on surfaces > 60 days	Can be delivered in aerosol or water solution (for water cannons)
	Agent OC and PAVA	Pepper odour or odourless white solid; soluble in oil. OC is naturally concentrated, PAVA is synthetic (and can be more potent)	30 – 60 minutes	Not established	As an oil, must typically be washed off with soap and water	Persists for long periods as oil or solid	Most commonly used in sprays, growing use in riot control dispersals

Figure 7: Characteristics of selected chemical irritants\*

\* Table adapted from Carron and Yerson, *Management of the Effects of Exposure to Tear Gas*, 2009.<sup>100</sup> \*\* The Median Incapacitating Dose (ID50) is the amount of agent expected to incapacitate 50 per cent of a group of exposed, unprotected individuals. The Median Lethal Dose (LD50) is the amount of agent expected to kill 50 per cent of a group of exposed, unprotected individuals. In pharmacology, the margin of safety is the range between the usual effective dose and the dose that causes severe or life-threatening side effects. Agent CS has a lower effective dose and a higher toxicity dose than agent CN, resulting in a wider margin of safety.

## Health effects

The health effects of chemical irritants are highly dependent on the specific chemical of exposure, the dose (based on quantity and time), the conditions of exposure, the deployment mechanism, the risk factors of the individual, and the access to egress and care. Most exposures to chemical irritants result in temporary pain and discomfort lasting less than one hour. However, the lacrimator gases are known overall to be more toxic than the capsaicin agents, particularly to the respiratory system, and both have the potential for more serious or longer-lasting injury at higher doses. Dose exposure is dependent on numerous factors that together can lead to higher or lower concentrations of the chemicals to which individuals are exposed. The amount of chemical released per canister, the number of canisters released, the context (indoors, outdoors, wind conditions), and how long an individual is exposed can all change the dose exposure.

The individual health risks for an individual are related to the exposure as well as personal characteristics and access to care. For instance, certain groups that are particularly at risk from the effects of chemical irritants and for whom it may be life-threatening include older people, children, or people with respiratory problems or skin sensitivity. According to the American Academy of Paediatrics, “[c]hildren are uniquely vulnerable to physiological effects of chemical agents. A child’s smaller size, more frequent

number of breaths per minute and limited cardiovascular stress response compared to adults magnifies the harm of agents such as tear gas.”<sup>101</sup> For many irritants, early decontamination can avoid the most severe injuries. Thus, the availability of water, soap, fresh air, or other treatments is an important factor to consider. Of note, different agents have different treatment considerations: fresh air is effective for all, but water can cause a transient exacerbation of symptoms for CS, CR and CN with eventual improvement, while soap is usually necessary for oil-based compounds such as OC and PAVA.

Transient and common symptoms from chemical irritant exposure include tearing, eye pain and redness, blepharospasm (eyelids involuntarily spasm and stay closed) and sensations of pain and burning on the skin. Exposed individuals often also feel pain in their mouth, airways and lungs and can have trouble breathing or have involuntary coughing fits. More serious injuries can affect all organ types: eye injuries, lung damage, skin burns and others. Perhaps most concerning, the canisters and grenades that are directed at crowds are known to be a significant source of traumatic injury.

## Results of the updated systematic review

We updated the systematic review of the medical literature documenting the health impact of different chemical irritants, which was initially carried out in 2016, to identify additional documented cases of injuries, deaths, and permanent disability. We

---

101 American Academy of Pediatrics, “AAP Statement in Response to Tear Gas Being Used Against Children at the U.S. Southern Border,” 26 November 2018, accessible at: <https://www.aap.org/en/news-room/news-releases/aap/2018/aap-statement-in-response-to-tear-gas-being-used-against-children-at-the-us-southern-border/>.

followed the same search process but also included case reports describing injuries of five people or fewer in an effort to elucidate the more severe injuries documented in smaller case reports in order to deepen understanding of the health impacts of chemical irritants (There is no standard reporting mechanism for deaths and severe injuries from these weapons, so case reports are a critical source of information). Based on our systematic review findings, we have catalogued additional injuries documented in the medical literature between 1 January 2015 and 28 February 2022 (the previous study reviewed data between 1 January 1990 and 15 March 2015). A total of 41 studies (36 in English, 5 in other languages) were included in our analysis of health effects as well as the frequency, context of injuries, and risk factors (See the appendix for a list of the referenced papers).

The majority of papers utilised a cross-sectional analysis (n=20) or case report (n=18) methodology (3 were surveys). The majority of studies described health effects from events in which chemical irritants were used in the USA (n=16), followed by Turkey (n=8) and Hong Kong (n=4). There were also studies from Belgium, Canada, France, Iraq, Lebanon, Slovenia, Spain, Switzerland and Tunisia. Eleven of the studies reported that injuries occurred secondary to public demonstrations, six studies explored events that occurred in training, three studied injuries in accidental exposures, and others included police use of force cases and experimental studies.

The review identified 119,113 people who were exposed to chemical irritants since 2015 reported in the medical literature. They had 129,451 injuries (some people had more than one injury). Of those injuries, 56% (n=72,468) resulted in transient symptoms such as pain, tearing, or respiratory distress that resolved quickly and spontaneously. 37% (n=47,629) constituted minor injuries that were visible on medical examination but expected to spontaneously resolve either with time or through first aid or other short-term interventions. Four per cent of injuries (n=5246) were severe, requiring medical interventions such as a hospital stay or surgery. And 3 per cent (n=4108) did not specify the severity. In this analysis, 19 people were permanently disabled, and 14 people died.

These numbers represent a significant increase in reporting and publication of data from the previous study. Our earlier study identified 8311 people who suffered injuries (of whom 13 people died and 70 people suffered permanent disability). Of note, the updated review includes three papers summarising large database analyses of persons reporting to toxicology centres or documented in national databases that include data on 104,940 people with tear gas and pepper spray exposures which significantly expands the sample for this updated review. While greater numbers of people were reported on, these large databases provide limited information beyond deaths and general injury categories, limiting analysis of their raw data. The majority of people from 1900 and 2015 who were injured also fully recovered from



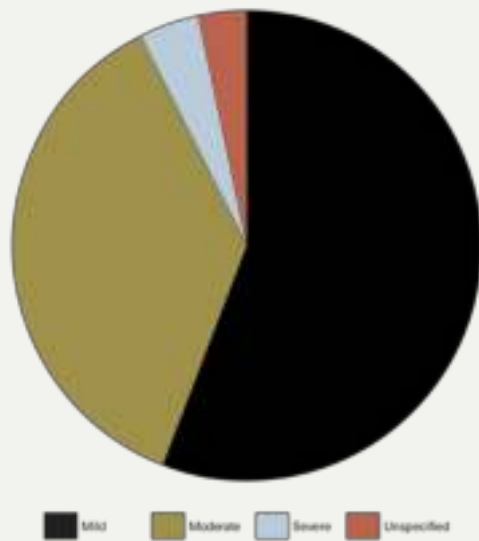

Figure 8: Severity of injuries caused by chemical irritants.

their injuries (98.7%).<sup>102</sup> Similar proportions of individuals had severe injuries in the updated analysis to the previous report (8.7% in the past report).

The updated analysis further found more cases of blunt trauma from canisters. All of the people who died suffered blunt head trauma from canisters being fired directly at them (11 individuals in Iraq, 3 in Syria). In all of these cases, the canisters were suspected to be high-density military-grade canisters. The deaths were documented in the literature review; one as a result of respiratory arrest after CS was fired inside a home, and twelve from traumatic brain injury sustained after the victim was directly hit by a canister. Ten of the deaths from head injury were reported in a study from Iraq on violence occurring during protests in 2019 and another from a separate case report in Iraq. No cases of death associated with OC were identified.

Nineteen people reported permanent disabilities, including permanent vision loss (two from a pepper ball that hit the eye and another from a direct spray of OC into the eye). Three people suffered from cardiac arrests (heart-stopping and requiring CPR), and two suffered permanent heart damage after exposure to chemical irritants. One person developed Guillain-Barre Syndrome, a neurological syndrome that causes paralysis after exposure.

Severe injuries surveyed included injuries to multiple body systems, with the majority of injuries being to the skin, eyes, and cardiopulmonary system (lung, heart, and chest).

Many of the studies reviewed for this report included injury data on children (some as

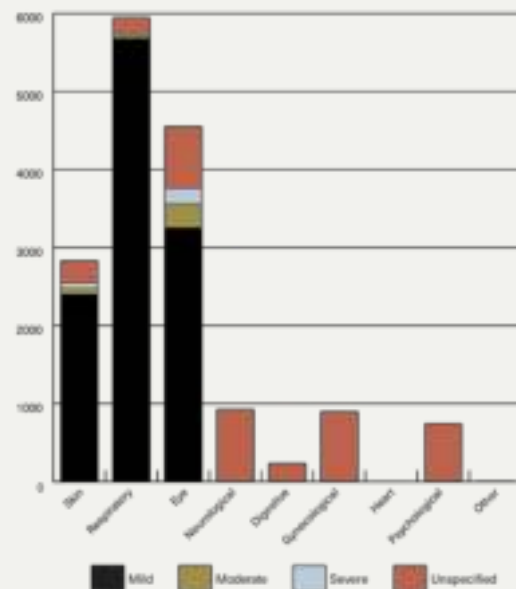

Figure 9: Severity of injuries caused by chemical irritants by body system.

102 RJ Haar, V Lacopino, N Ranadive, SD Weiser, and M Dandu. "Health impacts of chemical irritants used for crowd control: a systematic review of the injuries and deaths caused by tear gas and pepper spray." *BMC Public Health* 17, no. 1 (2017): 1-14.

young as three months old). Studies suggest that children are more vulnerable to severe injuries from chemical toxicity.<sup>103</sup> The elderly and those with chronic diseases may also be more prone to worse outcomes from chemical irritants.<sup>104</sup> The data also identified chronic respiratory conditions and allergic skin conditions in people who had previous medical conditions and severe lung and heart injuries in individuals with no past history of any medical concerns (including police officers).

The review also found that the severity of injuries from chemical irritants was correlated with the kind of chemical agent used and the method of deployment.

- › Type of chemical agent: Most of the injuries documented were caused by CS or OC, but the injuries were rarely disaggregated by the chemical involved. In many cases, the specific agent was not known. Among the studies where the chemical agent was identified as CS, 573 injuries were reported. Of those, 10% suffered severe injuries, 38% suffered moderate injuries, and 51% experienced mild injuries. Among the studies where the chemical agent was identified as OC or PAVA, 2925 injuries were reported. Of those, 12% were severe, 18% were moderate, and 70% were mild.

Narrative data collected from reviewed literature suggested that agent CS can

cause unexpected skin reactions, such as chemical burns and hypersensitivity reactions, as well as respiratory illness. OC can also cause such reactions. Significant severe reactions, such as cardiac arrest, strokes and skin burns, were reported with both agents.

- › Deployment mechanism: The selected studies documented injuries caused by both spray and gas forms of both chemicals. While the previous review demonstrated that gas forms of chemical irritants (contained in canisters or grenades and released and widely dispersed by a thermal explosion) contributed to a marginally higher percentage of severe injuries, the updated data does not deepen

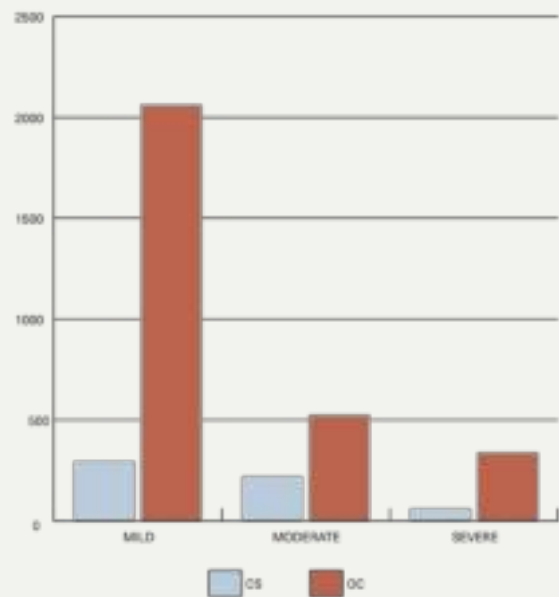

Figure 10: Injury severity by chemical agent.

103 PJ Landrigan, "Children as a Vulnerable Population," *International Journal of Occupational Medicine and Environmental Health* 17, no. 1 (2004): 175–77.

104 PA Routledge, MS O'Mahony, and KW Woodhouse, "Adverse Drug Reactions in Elderly Patients," *British Journal of Clinical Pharmacology* 57, no. 2 (February 2004): 121–26, doi:10.1046/j.1365-2125.2003.01875.x.

this analysis given the lack of quality data on deployment. The current review reinforced the importance of both distance/proximity to the area where the chemical was released and the force of the propellant as factors influencing the severity of the health effect on individuals.

The additional data since 2016 has underscored the concern over blunt trauma injuries from chemical irritant canisters. Direct hits by the canisters themselves were documented to have caused 59 injuries, 55 of which were to the head. A study from Iraq highlights the importance of the design of the canister and the apparently deliberate targeting of the heads of individual protesters. The canisters developed in Iran were denser than most other canister designs.

Many of the reviewed studies identified additional factors that may potentiate injuries, such as environmental conditions (heat, humidity, and wind conditions), prolonged exposure, and exposure in enclosed spaces. Utilising the weapons in confined spaces and in areas where people could not easily escape was noted to potentially increase the exposure to the irritant either in quantity or over time.<sup>105</sup> Use of chemical irritants in areas with high heat or humidity potentially exacerbated skin irritation, and windy conditions risked the contamination

of law enforcement officers, bystanders, or nearby residences and businesses.<sup>106</sup> Direct targeting of the face and eyes by spray has been noted to cause trauma and toxicity to the cornea and conjunctiva of the eye.

In addition to documenting injuries, the review identified other factors that may affect injury severity. Inherent qualities of the chemical agents may play some role in injuries. Chemical irritants, especially those deployed in gas forms, are inherently indiscriminate and can impact not only the intended targets but also other demonstrators, bystanders, neighbourhood businesses and residences, and law enforcement officers themselves. Several of the reviewed studies demonstrated that accidental exposure is common and sometimes difficult to avoid. Because of the indiscriminate nature of chemical irritants, limiting the exposure to individuals or small groups is difficult, while exposing large and diverse groups to the weapons poses the risk of widespread injuries, including to potentially vulnerable people.

We also note that combinations of OC and CS are becoming more common, both in spray and gas forms as well as within projectiles such as the “pepper ball.”<sup>107</sup> These forms, along with chemical agents dissolved in water cannons, have not been well studied and could cause other injuries.<sup>108</sup> Perhaps even more concerning are the unknown

---

105 AMB Zekri et al., “Acute Mass Burns Caused by O-Chlorobenzylidene Malononitrile (CS) Tear Gas,” *Burns* 21, no. 8 (1995): 586–89, doi:10.1016/0305-4179(95)00063-H.

106 RJ Thomas et al., “Acute Pulmonary Effects from O-Chlorobenzylidenemalonitrile ‘Tear Gas’: A Unique Exposure Outcome Unmasked by Strenuous Exercise after a Military Training Event,” *Military Medicine* 167, no. 2 (February 2002): 136–39.

107 EJ Olajos and H Salem, “Riot Control Agents: Pharmacology, Toxicology, Biochemistry and Chemistry,” *Journal of Applied Toxicology: JAT* 21, no. 5 (October 2001): 355–91.

108 *Tear Gas Devices, Code of Federal Regulations*, vol. 173.340, 2001, accessible at: <https://www.law.cornell.edu/cfr/text/49/173.340>.

effects of these chemical agents in chronic exposure settings in which safety has never been studied and cannot reasonably be assumed. This should be particularly concerning for law enforcement officers with repeated exposure, frequent protesters, and health workers who may sustain multiple occupational exposures. More research on these possible health harms is needed. (For specific recommendations on chemical irritants, see Section 4).

## What has changed?

Much of the research in the past six years amplifies the concerns presented in LiD1. In addition, a number of new concerns have emerged.

- › Extensive use: Tear gas has continued to be used extensively across the globe. From Hong Kong to Chile, chemical irritants continue to be the primary riot control agent utilised by police to repress and disperse demonstrations. In the United States, the police response to anti-police violence protests in the wake of George Floyd's murder included widespread use of different forms of tear gas in dozens of cities.
- › New ways of deployment: In Colombia, the use of the US-made "venom" launchers, which can deploy dozens of grenades at once from stations mounted on vehicles, shields or static installations, led to the rapid diffusion of massive quantities of chemical irritants at protests across the country in 2021. Beyond the use of traditional canisters and grenades, the use of chemical irritants diluted in water cannons is a growing problem, with reports of resulting skin irritation and pain. There has also been growing use of other composite weapons, such as pepper balls. These composite weapons are anecdotally considered less dangerous than traditional kinetic impact projectiles but must be regarded as both projectile and chemical weapons and have been few studies.
- › Few advances in knowledge or dissemination of knowledge on composition: In the past six years, there have been little to no efforts on the part of governments or regulating bodies to better understand the composition of chemical irritants or make that knowledge available to the public or to healthcare workers. As examples:
  - » The United States National Institute for Occupational Safety and Health (NIOSH) still does not index Agent CS in its database (though it does have Agent CN).
  - » Data on the chemical makeup of various formulations, made by numerous manufacturers, are challenging to obtain and remain opaque to the public.
  - » Police documentation of the use of force is haphazard and limited: deployment records are not readily available and, when they are, frequently lack sufficient quality to analyse records.
- › A review of recent papers also highlights that in light of the lack of a clear standard for how to report chemical irritant

injuries, studies are heterogeneous in their approaches. This heterogeneity makes systematic comparisons across studies difficult.

- › New hazards recognized as a result of the airborne transmission of viruses, such as COVID-19: Since 2020, the ongoing COVID-19 pandemic has resulted in millions of deaths from respiratory illness. In this context, the extensive use of chemical irritants during the pandemic has increased the risk of adverse medical effects due to COVID-19's effects on breathing and the lungs, as well as the risk of infection through induced coughing or sneezing. This risk is especially high for those in enclosed or indoor spaces, or for communities with high incidence of COVID-19 and low vaccination rates. Numerous health organisations demanded a moratorium on the use of chemical irritants during demonstrations, citing the lack of crucial research, the escalation of tear gas use by law enforcement, and the likelihood of compromising lung health and promoting the spread of COVID-19" (American Thoracic Society, 2020). They were specifically worried that the use of chemical irritants could increase the risk of COVID-19 by making the respiratory tract more susceptible to infection, exacerbating existing

inflammation, and inducing coughing (Greiner et al., 2020). While there is limited information on the incidence of COVID-19 in the setting of tear gas exposure, this issue continues to be of concern as the pandemic rages on and others likely will follow.

- › The effects of chemical irritants on women: An area of increasing importance, but where no clinical studies have yet been published, is the growing awareness of the effects of chemical irritants on women and reproductive health. Anecdotal reports have suggested that there may be a relationship between the use of tear gas and miscarriage, but following the widespread use of large quantities of chemical irritants during BLM and other protests in the US in the summer of 2020, media reports also emerged of irregular menstruation, exacerbated cramping, or both of these in the weeks after chemical irritant exposure.<sup>109</sup> Self-reported menstrual issues were documented in Portland in 2020 in a convenience sample survey where, of people who could menstruate, 36% reported increased cramping, and 24% reported increased bleeding. Stress and other confounders may also play a role. As a result of such reports and the

---

109 See, for example, A Slisco, "Tear Gas May Have Led To Abnormal Menstrual Cycles in Seattle and Portland," *Newsweek* (5 September 2020), accessible at: <https://www.newsweek.com/tear-gas-may-have-led-abnormal-menstrual-cycles-seattle-portland-1529912>; M Stunson, "Protesters complain of unexpected side effect from tear gas: Period changes," *Miami Herald* (14 July 2020), accessible at: <https://www.miamiherald.com/news/nation-world/national/article244212707.html>; and C Nowell, "Protesters Say Tear Gas Caused Them to Get Their Period Multiple Times in a Month," *Teen Vogue* (2 July 2020), accessible at: <https://www.teenvogue.com/story/protestors-say-tear-gas-caused-early-menstruation>.



lack of research, several organisations are undertaking further research.<sup>110</sup>

- › Environmental and long-term risks: The mounting worries about the environment have led to more thoughtful consideration of the contamination of ground and water by the deployment of chemical irritants. There is a concern not only about the locations immediately surrounding where chemical irritants are used but also areas where their degradation products may spread. A study by members of this research team in Aida Camp in Palestine examined the effects of tear gas canister rounds left on the street (see case study below).<sup>111</sup> Children and others who handled these canister rounds days after they had been fired reported symptoms and signs consistent with chemical irritant exposure. In multiple settings, concerns have been reported about the degradation products of chemical irritants such as cyanide (a deadly poison). While the dose from a small canister may be low, evidence of expired canisters being used across the globe underscores the risk that numerous expired canisters could harm demonstrators, members of surrounding communities, and the environment. Degradation products in both ground and run-off streams are

now being studied by several groups to answer some of these questions.

- › Psychological Impacts: The psychological impact of the use of CCWs has not been well studied or documented in the medical literature, but cases documented in this review indicate that exposure to chemical irritants may result in significant psychological symptoms and long-term disability. In one study of 297 individuals seeking care and/or evaluations of injuries following the 2013 Gezi Park protests in Turkey, 117 psychiatric evaluations were conducted. Some 43 per cent of the victims met the diagnostic criteria for acute stress disorder, 23 per cent met the diagnostic criteria for post-traumatic stress disorder (PTSD), and 7.7 per cent met the diagnostic criteria for major depressive disorder.<sup>112</sup> In 2020, 1635 (72.4%) of 2257 adults who reported tear gas exposure in Portland, US, described in a web-based survey that they were experiencing increased feelings of fear, fatigue, anxiety, and/or a startle response.
- › Scant evidence on the treatment of chemical irritant exposure: Treatment of chemical irritant exposure has gained increased attention over the past six years. Studies and commentaries have reiterated prior recommendations that

---

110 Planned Parenthood North Central States, "Tear Gas and Reproductive Health Study," *plannedparenthood.org*, accessible at: <https://www.plannedparenthood.org/planned-parenthood-north-central-states/about-ppnccs/research/tear-gas-and-reproductive-health-study>.

111 Human Rights Center, "No Safe Space: Health Consequences of Tear Gas Exposure Among Palestine Refugees," *University of California Berkeley*, accessible at: <https://humanrights.berkeley.edu/programs-projects/past-projects/no-safe-space>.

112 Umit Unuvar, et al. "Usage of Riot Control Agents and other methods resulting in physical and psychological injuries sustained during civil unrest in Turkey in 2013." *Journal of Forensic and Legal Medicine* 45 (2017): 47-52.

most symptoms of chemical irritant exposure should resolve spontaneously within an hour of the end of the exposure. There is anecdotal evidence to suggest that tear gas (CS and CN) exposure is best treated with fresh air or copious amounts of water irrigation and that pepper spray (OC and PAVA) might be best treated with soap and water (as it is an oil-soluble compound).<sup>113</sup> A small, randomised control trial noted that treatment with baby shampoo was no different than irrigation with water alone for both CS and OC exposures.<sup>114</sup>

- » While there are anecdotal reports of a variety of substances helping with symptoms, there is little evidence to support their use. Nevertheless, antacids and alkaloids, such as Maalox or milk of magnesia, are commonly used around the world for symptomatic relief. In some cultures, onions, citrus fruits, CocaCola, and

strong-smelling salts are used to counteract the immediate effects of chemical irritants. In one study, pre-treatment of police officers with Diphoterine (a common chemical rinsing agent) resulted in slightly less facial pain when they were exposed.<sup>115</sup> Current evidence suggests that exposed individuals should attempt to remove contaminated clothing, and those with contact lenses should remove them immediately. Individuals with severe respiratory symptoms, prolonged palpitations, blisters/burns, or any symptoms lasting longer than an hour should seek medical attention. Anyone with blunt trauma from a tear gas canister, especially to the head or face, should seek immediate medical attention.

**The psychological impact of the use of CCWs has not been well studied or documented in the medical literature, but cases documented in this review indicate that exposure to chemical irritants may result in significant psychological symptoms and long-term disability.**

---

113 See Fine, Kennet., Bassin, and Stewart. "Emergency care for tear gas victims." *Journal of the American College of Emergency Physicians* 6, no. 4 (1977): 144-146; and Carron, Pierre-Nicolas, and B Yersin. "Management of the effects of exposure to tear gas" *BMJ* 338 (2009).

114 JD Barry, RHD James, and JG McManus Jr. "A randomized controlled trial comparing treatment regimens for acute pain for topical oleoresin capsaicin (pepper spray) exposure in adult volunteers", *Prehospital Emergency Care* 12, no. 4 (2008): 432-437.

115 M Brvar, "Chlorobenzylidene malonitrile tear gas exposure: Rinsing with amphoteric, hypertonic, and chelating solution." *Human & Experimental Toxicology* 35.2 (2016): 213-218.

## Case study

## No safe space in refugee camps

### Palestine

After the publication of LiD1 in 2016, aid workers in the Aida and Dheisheh refugee camps outside of Bethlehem, in Palestine, reached out to the authors. The camps are decades old, small, densely-populated—and adjacent to the Separation Wall in some places. Residents reported exposure to tear gas two to three times a week for more than a year. In some months, the exposure was almost daily. Staff in the camps worried the tear gas was used in breach of international norms and to the significant health detriment of the community.

Responding to the request for support, researchers at UC Berkeley and UC San Francisco put together a team to study the issue. The aim of the study was to: (1) identify the frequency of exposure to tear gas among refugees who live in Aida and Dheisheh camps; and (2) categorise potential medical and psychological symptoms (both acute and chronic) associated with this exposure.

In the summer of 2017, researchers travelled to Bethlehem to conduct the research. The findings, published in the report *No Safe Space* by the Human Rights Center at UC Berkeley School of Law, revealed that the use of chemical irritants in these camps likely far surpassed anything seen anywhere else on the globe. And because the camps are tightly packed with poor ventilation, tear gas was entering homes and lingering in the air as well as on the ground. Children were playing with used canisters, and nearly

everyone, from babies to the elderly, was experiencing symptoms from the chronically high exposure. There truly was “no safe space” and no way out.

Researchers conducted 10 focus groups with over 75 participants and interviewed 236 individuals in the camp, ages ten and older, as part of a household population survey. Fully 100% of residents surveyed reported being exposed to tear gas in the past year. Respondents also reported being exposed in the past several years to stun grenades (87%), skunk water (a foul-smelling liquid; 85%), and pepper spray (54%). Respondents also reported witnessing the use of rubber bullets (52%), and several (6%) also reported witnessing the use of live ammunition (6%). Over half (55%) of respondents described between three and 10 tear gas exposures in the month before the survey was carried out, both indoors and outdoors. Indoor locations included homes, schools, and places of work.

Over the same period, 84.3% were exposed to tear gas in the home, 9.4% at work, 10.7% in school, and 8.5% elsewhere (in a car for instance). Fifty-three people (22.5%) said that they had been hit directly with a tear gas canister in the past. Community focus groups consistently and independently reported experiences of fear, worry, physiological reactivity, hyper-arousal, poor and disrupted sleep, lack of safety, and daily disruptions in basic activities of daily living—including caring for children and the sick, participating



ISRAELI FORCES FIRE TEAR GAS INTO AIDA REFUGEE CAMP, BETHLEHEM, WEST BANK, SEPTEMBER 27, 2013. THE CLASHES WERE IN REACTION TO RECENT PROVOCATIONS AT JERUSALEM'S AL AQSA MOSQUE BY RIGHT-WING JEWISH SETTLERS. RYAN RODRICK BEILER | ACTIVE STILLS

The use of military-grade ammunition for crowd control is unusual, and typical tear gas canisters do not pose the same magnitude of hazard. However, with little to no regulation of chemical irritants, these weapons were manufactured, purchased, and used against civilians, with no limitations. Worryingly, direct impacts to the head from “civilian grade” tear gas canisters have been documented to cause injuries ranging from traumatic brain injury,<sup>1</sup> skull fracture,<sup>2</sup> enucleation,<sup>3</sup> and death.<sup>4</sup>

1 Committee to Protect Journalists, “Video journalist injured by tear gas canister at Hong Kong protest,” *Committee to Protect Journalists*, 5 August 2019, accessible at: <https://cpj.org/2019/08/video-journalist-injured-by-tear-gas-canister-at-h/>

2 Charis McGowan, “Mom Loses 3 Senses After Cops Threw Tear Gas Canister Into Her Face, Sparking a Movement Against ‘Non-Lethal’ Weapons in Chile,” *VICE News*, September 17, 2020, accessible at: <https://www.vice.com/en/article/wxq3qw/this-mom-lost-3-of-her-senses-after-being-hit-by-a-teargas-canister-sparking-a-movement-against-non-lethal-weapons-in-chile>.

3 A Srikanth, “Indiana journalist loses eye to tear gas canister during demonstrations against George Floyd’s death,” *The Hill*, June 1, 2020, accessible at: <https://thehill.com/changing-america/respect/equality/500467-texas-journalist-loses-eye-to-tear-gas-canister-during/>.

4 Wani et al., “Head injury caused by tear gas cartridge in teenage population,” *Pediatric Neurosurgery*, 2010, vol. 46, no. 1, pp. 25-28, doi:10.1159/000314054

## Case study

## Shrapnel in stun grenades and tear canisters cause over 28 deaths



Iraq

The 2019 October protests that affected central and southern Iraq were initially violently repressed by government and paramilitary forces, resulting in over 500 fatalities.<sup>116</sup> Although the majority of deaths resulted from live fire, the second wave of protests in late October was characterised by the deadly use of CCWs, with 28 deaths attributed to shrapnel from stun grenades and impacts from tear gas canisters.<sup>117</sup> Extensive video documentation revealed that tear gas canisters were direct-fired at protesters along a horizontal trajectory,<sup>118</sup> a method of use that poses a high risk of severe to fatal injury.<sup>119</sup>

The rounds responsible for these wounds were military-grade Serbian M99 grenades or Iranian M651 tear gas / M713 smoke grenades.<sup>120</sup> Although government sources denied the use and import of these weapons, instead blaming non-government instigators, further research revealed the Serbian grenades were part of a \$235 million arms deal struck between Serbia and Iraq in 2008, with the intended end user being the Iraqi Ministry of Defense.<sup>121</sup> These “barrier-penetrating” rounds can have effects comparable to those of a 12-gauge shotgun slug and pose extreme danger in crowd-control settings.<sup>122</sup> A typical US CS canister weighs 25-50 grams. These weigh 250-280 grams.

116 Reuters Staff, “Iraq says nearly 560 killed in anti-government unrest,” *Reuters*, (30 July 2020), accessible at: <https://www.reuters.com/article/us-iraq-protests-government/iraq-says-nearly-560-killed-in-anti-government-unrest-idUSKCN24V2JL>.

117 United Nations Assistance Mission for Iraq, “Human Rights Violations and Abuses in the Context of Demonstrations in Iraq: October 2019 to April 2020,” *Office of the United Nations High Commissioner for Human Rights*, (August 2020), Baghdad, Iraq, accessible at: <https://www.ohchr.org/sites/default/files/Documents/Countries/IQ/Demonstrations-Iraq-UNAMI-OHCHR-report.pdf>.

118 Human Rights Watch, “Iraq: Teargas Cartridges Killing Protesters,” *Human Rights Watch*, 8 November 2019, accessible at: <https://www.hrw.org/news/2019/11/08/iraq-teargas-cartridges-killing-protesters>.

119 United Nations Assistance Mission for Iraq, “Demonstrations in Iraq: update,” *Human Rights Special Report*, 25 October - 4 November, 2019, Baghdad, Iraq, accessible at: [https://www.ohchr.org/sites/default/files/Documents/Countries/IQ/3rd\\_UNAMI\\_report\\_Human\\_Rights\\_and\\_Demonstrations\\_9\\_Dec\\_2019.pdf](https://www.ohchr.org/sites/default/files/Documents/Countries/IQ/3rd_UNAMI_report_Human_Rights_and_Demonstrations_9_Dec_2019.pdf).

120 Amnesty International, “Gruesome string of fatalities in Iraq as new tear gas grenades pierce protester’s skulls,” *Amnesty International*, (13 October 2019), accessible at: <https://www.amnestyusa.org/press-releases/gruesome-string-of-fatalities-in-iraq-as-new-tear-gas-grenades-pierce-protesters-skulls/>.

121 M Ristic et al., “‘Epic’ Serbian Arms Deal Led to Pierced Skulls in Baghdad,” *Balkan Insight*, (13 December 2019), accessible at <https://balkaninsight.com/2019/12/13/epic-serbian-arms-deal-led-to-pierced-skulls-in-baghdad/>.

122 Amnesty International, “Smokescreen - Iraq’s use of military-grade tear gas grenades to kill protesters,” *Amnesty International*, accessible at <https://teargas.amnesty.org/iraq/>.





SECURITY FORCES FIRED TEARGAS CARTRIDGES DIRECTLY AT PROTESTERS IN BAGHDAD, IRAQ ON NUMEROUS OCCASIONS SINCE PROTESTS RESUMED ON OCTOBER 25, 2019, KILLING DOZENS OF PROTESTERS, ACCORDING TO HUMAN RIGHTS WATCH. YOUTUBE | HUMAN RIGHTS WATCH

The use of military-grade ammunition for crowd control is unusual, and typical tear gas canisters do not pose the same magnitude of hazard. However, with little to no regulation of chemical irritants, these weapons were manufactured, purchased, and used against civilians, with no limitations. Worryingly, direct impacts to the head from “civilian grade” tear gas canisters have been documented to cause injuries ranging from traumatic brain injury,<sup>123</sup> skull fracture,<sup>124</sup> enucleation,<sup>125</sup> and death.<sup>126</sup>

123 Committee to Protect Journalists, “Video journalist injured by tear gas canister at Hong Kong protest,” *Committee to Protect Journalists*, 5 August 2019, accessible at: <https://cpj.org/2019/08/video-journalist-injured-by-tear-gas-canister-at-h/>

124 Charis McGowan, “Mom Loses 3 Senses After Cops Threw Tear Gas Canister Into Her Face, Sparking a Movement Against ‘Non-Lethal’ Weapons in Chile,” *VICE News*, September 17, 2020, accessible at: <https://www.vice.com/en/article/wxq3qw/this-mom-lost-3-of-her-senses-after-being-hit-by-a-teargas-canister-sparking-a-movement-against-non-lethal-weapons-in-chile>.

125 A Srikanth, “Indiana journalist loses eye to tear gas canister during demonstrations against George Floyd’s death,” *The Hill*, June 1, 2020, accessible at: <https://thehill.com/changing-america/respect/equality/500467-texas-journalist-loses-eye-to-tear-gas-canister-during/>.

126 Wani et al., “Head injury caused by tear gas cartridge in teenage population,” *Pediatric Neurosurgery*, 2010, vol. 46, no. 1, pp. 25-28, doi:10.1159/000314054

## Case study

## Byron Guatucuca and the lethality of tear gas canisters

 Ecuador

Byron Guatucuca, a member of the Kichwa community from San Jacinto, Puyo, a town in the Ecuadorian Amazon, was killed in a police operation while participating in a peaceful demonstration that was part of a national indigenous strike called by the Confederation of Indigenous Nationalities of Ecuador. On the night of 21 June 2022, the Ecuadorian national police and military began to clear roads blocked by the demonstrators. Security forces fired tear gas canisters, causing panic and choking among the crowd, including elderly people, women, and children. A tear gas canister fired from close range hit Guatucuca in the face, fractured his skull, and entered his brain, causing his death. He was shot from the front and at a short range. The impact from the canister had a grave effect on the cerebral region, which produced a haemorrhage, loss of consciousness and, finally, his death.

Videos posted on social media and local news<sup>127</sup> show clouds of tear gas, choking and running civilians, and chaos. Guatucuca is seen as he is hit by a tear gas canister and falls to the ground, smoke pouring from his head.<sup>128</sup> Mia Sonovision, a local media outlet, interviewed a demonstrator who was standing next to Guatucuca, who stated: “The boy was killed when he got shot from the front.

He was next to me. I tried to take the canister out of his eye.” The witness then showed his arm, stained with Byron’s blood.<sup>129</sup>

The police issued a statement arguing that Guatucuca died from “handling an explosive device,” an account that was later supported by the Ministry of the Interior. However, shortly thereafter, images of the CT scans performed on Guatucuca at the Puyo Regional Hospital were posted on social media, showing a tear gas canister lodged in his skull. This evidence not only undermined the official account but showed that it was a deliberate falsification. The veracity of the medical studies was confirmed by the director of the Puyo Hospital.

The attack on Guatucuca represents an excessive and illegal use of force and led to a request for the State Attorney General’s Office to open a criminal investigation. The Attorney General’s Office of Pastaza Province involved more than 80 police officers in the preliminary investigation but has not yet made progress on key elements such as the list of officers who were carrying weapons capable of firing tear gas canisters. According to Jessika Delgado—the local lawyer who is leading the case alongside the Regional Human Rights Advisory Foundation (INREDH)—the attorney

127 See <https://bit.ly/3Carg89>.

128 See <https://bit.ly/3Su3SYA>.

129 <https://bit.ly/3xXID9R>.



SCAN IMAGES SHOW THE GAS CANISTER LODGED INSIDE THE VICTIMS' SKULL. | IMAGE PROVIDED BY LA CONFEDERACIÓN DE LAS NACIONALIDADES INDÍGENAS DE LA AMAZONIA ECUATORIANA (CONFENIAE) VIA TWITTER @CONFENIAE1

general's office seems to be deliberately delaying the investigation. Two months have elapsed and only six statements have been taken, none of which came from officers who admitted to being at the scene.

Byron Guatatuca was 42 years old and had four children. His family and several organisations continue to demand a thorough investigation to determine criminal liability and the chain of command and to hold those responsible accountable for the use of force, including the use of so-called "less-lethal weapons." Guatatuca's case makes clear that tear gas canisters can cause serious injury and even death, depending on how they are fired. Accordingly, they require far greater regulation and scrutiny than they currently receive.

## Case study

# Tear gas used by police causes panic in Kanjuruhan Stadium and 135 deaths

## Indonesia

On 1 October 2022, the deadliest football tragedy of the 21<sup>st</sup> century unfolded at Kanjuruhan Stadium in Malang, Indonesia, after police shot tear gas in a packed stadium. As a result, 135 fans were crushed in the ensuing chaos, among which 40 children and over 500 supporters were injured.

That night, as the referee's whistle sealed the game's results, fans took to the pitch. Police immediately replied by shooting chemical irritants at the field and then at the stands. More than 40 rounds of tear gas, flash bangs and flares were shot at fans within ten minutes<sup>130</sup>, creating mass panic and a rush towards the scant and narrow exits. The gates were only wide enough for two persons to exit at a time, and some were locked.<sup>131</sup>

These events were largely reported by local and foreign media. In the outcry following the tragedy, a multidisciplinary investigation was ordered by President Joko Widodo. The team, composed of government officials and football and security experts, concluded that

the tear gas—prohibited in sports venues under Indonesian police protocol—was indeed the main cause of deaths. The Malang chief of police was dismissed and an investigation was opened on scores of police officers. In its 124-page report, the investigation team also asked for the resignation of the chairman and the executive board of PSSI, Indonesia's football association.<sup>132</sup>

Indonesian human rights NGO and INCLO member Commission for Disappeared Persons and Victims of Violence (KontraS) took part in the Civil Society Coalition Fact-Finding Team which led a parallel independent inquiry<sup>133</sup> of the police intervention. They discovered another set of facts also pointing to the police's responsibility in the tragedy, but they also highlight the systematic nature of these human rights violations whose planning involved high-ranking officials who were not accountable under the government commissioned investigation. KontraS also discovered that witnesses had suffered intimidation on behalf of authorities

130 R Tan, J Sohyun Lee, S Cahlan, I Piper and A Llewellyn, "How police action in Indonesia led to a deadly crush in the soccer stadium," *The Washington Post*, 6 October 2022. Accessible at: <https://www.theguardian.com/world/2022/oct/19/indonesia-to-demolish-football-stadium-where-scores-died-in-crowd-crush>

131 See Guardian, *Indonesia to demolish football stadium where scores died in crowd crush* (19 October 2022), accessible at: <https://www.theguardian.com/world/2022/oct/19/indonesia-to-demolish-football-stadium-where-scores-died-in-crowd-crush>.

132 CNN, *Police's tear gas main cause of death in Indonesia soccer stampede: investigators*, accessible at: <https://edition.cnn.com/2022/10/14/asia/indonesia-stadium-disaster-tear-gas-investigation-intl-hnk/index.html>.

133 KontraS, 12 Initial Findings of the Civil Society Coalition Fact-Finding Team Regarding the Human Rights Violation Incident at Kanjuruhan Stadium, accessible at: <https://kontras.org/en/2022/11/05/12-initial-findings-of-the-civil-society-coalition-fact-finding-team-regarding-the-human-rights-violation-incident-at-kanjuruhan-stadium/>.





FOOTBALL SUPPORTERS ENTER THE PITCH AS SECURITY OFFICERS TRY TO DISPERSE THEM AFTER A SOCCER MATCH AT KANJURUHAN STADIUM IN MALANG, EAST JAVA, INDONESIA, 01 OCTOBER 2022. ACCORDING TO GOVERNMENT OFFICIALS, AT LEAST 174 PEOPLE INCLUDING POLICE OFFICERS WERE KILLED MOSTLY IN STAMPEDES AFTER RIOTS FOLLOWING A SOCCER MATCH. SURYANTO | ANADOLU AGENCY VIA GETTY IMAGES

after the events which are considered a means to deter survivors from telling their story.

KontraS interviewed many witnesses, some of which were still recovering from the array of injuries provoked by the stampede, ranging from bruises to fractures, concussions, rashes on the face and body, respiratory distress and post-traumatic stress. Most deadly victims are suspected to have perished from suffocation and internal bleeding, some crushed against walls, others trampled against the ground.

Numerous witness accounts claim that authorities gave no verbal warning before shooting, first at the pitch and then at the stands. Firing chemical irritants into closed spaces or open spaces where there is no safe egress should be prohibited, as clearly stated in the

2020 UN Guidance on the Use of Less-Lethal Weapons in Law Enforcement<sup>134</sup> and reiterated by FIFA guidelines. Following numerous football stadium tragedies across the globe in similar circumstances, the international soccer federation has also regulated against the use of tear gas in international games, but has done little or nothing for this to be enforced locally.

On 18 October 2022, Indonesia announced its plans to demolish Kanjuruhan Stadium and rebuild another one compliant with FIFA regulations. At that point, six people, including police officers and organizers, were facing charges over the crush for criminal negligence and causing death, which carries a maximum sentence of five years.<sup>135</sup>

134 See UN Guidance on LLWs above n 6 at 29.

135 BBC, *Kanjuruhan stadium: Indonesia to demolish site of arena disaster*, accessible at <https://www.bbc.com/news/world-asia-63301863>.





# WATER CANNONS

PROTEST AGAINST POLICE BRUTALITY AND RACISM AGAINST THE ISRAELI-ETHIOPIAN COMMUNITY, TEL AVIV, ISRAEL, MAY 3, 2015. YOTAM RONEN | ACTIVE STILLS

## Weapon profile

Streams of water are commonly used as CCWs. Typically referred to as water cannons, these weapons include various types of water hoses that are either connected to in-ground water supplies or mobile bladders (often on trucks) and are used to disperse crowds or limit access to certain areas.<sup>136</sup> Water cannons were first used for crowd control in the 1930s in Germany, and by the 1960s were in frequent use in the United States during civil rights protests.<sup>137</sup> Water cannons have been used as a crowd-control weapon in protests all over the world and continue to be used regularly, now most often as vehicle-mounted devices.

## Mechanism of action

Water cannons function by propelling streams of water towards protesters. These can be either high-pressure streams aimed at pushing back crowds or low-pressure streams intended to douse. High-pressure water cannons can have flow rates (volume of fluid) of up to 20 litres of water per second, with an operating pressure of 15 bar (220 psi) and can stream water 67 metres away.<sup>138</sup> By comparison, a typical residential showerhead has a pressure of 3 bar (40 psi). High-pressure, high-volume water cannons can knock individuals down and push them backwards with significant force, particularly

136 "White-Washing the Water Cannon: Salesmen, Scientific Experts and Human Rights Abuses," *openDemocracy*, August 27, 2014, accessible at <https://www.opendemocracy.net/en/opensecurity/white-washing-water-cannon-salesmen-scientific-experts-and-human-rights/>.

137 MA Berger, *Seeing through Race: A Reinterpretation of Civil Rights Photography*, (Berkeley: University of California Press, 2011).

138 Author redacted, "Medical Implications of the Use of Vehicle Mounted Water Cannon (Issue 2.0)," (Defence Science and Technology Laboratory UK, February 2004), 67, [https://www.gov.uk/government/uploads/system/uploads/attachment\\_data/file/445174/040201\\_DSTL\\_3\\_-\\_Feb\\_2004\\_-\\_TR08591\\_-\\_Ready\\_for\\_publication.pdf](https://www.gov.uk/government/uploads/system/uploads/attachment_data/file/445174/040201_DSTL_3_-_Feb_2004_-_TR08591_-_Ready_for_publication.pdf).

when this pressure is sustained and exerted over a wide surface area.<sup>139</sup>

Recently, these weapons have evolved to include tear gas, coloured dyes, or other chemicals that are fired concurrently with the water. These additives increase the effectiveness of water cannons and also increase the likelihood of property damage or severe injury or death to protesters who are hit. The use of water cannons that include tear gas or other chemicals appears to be growing in popularity.

Coloured dyes, often semi-permanent and requiring several days and numerous cleanings with strong detergents to remove, have been used for more than 25 years in many places, including Hungary, India, Indonesia, Israel, Northern Ireland, South Africa, South Korea, and Uganda.<sup>140</sup> Coloured dyes have been used to humiliate protesters. Coloured dyes have also been used to publicly mark protesters, including so they can be arrested later.<sup>141</sup> Some water cannons even

fire ultraviolet dyes to assist in the delayed identification and arrest of protesters.<sup>142</sup>

Most modern water cannons can also be used with chemical irritants such as agent CS or OC, and chemical irritant manufacturers produce powdered versions for this purpose.<sup>143</sup> Foul-smelling chemicals have also been used in water cannons in recent years, often coating not only individuals but also nearby homes and businesses in malodorous and difficult-to-remove chemicals of unknown toxicity.<sup>144</sup> There are no publicly available guidelines on the appropriate use of water cannons, including details on minimum distance, water pressure, and use-of-force protocols. The 2016 LiD1 report found that foul-smelling chemicals were only used in the Occupied Palestinian Territories and in East Jerusalem. Since then, the purchase or testing of malodorants has been reported in a handful of other countries including Georgia and India, suggesting a rise in the use of this tactic and underscoring the expanding market for this new technology.<sup>145</sup>

---

139 "Turkey Protest Turns Violent , Headshot of a protester by a water cannon," Youtube (Turkey, 2013), accessible at: <https://www.youtube.com/watch?v=ow8o9yxU0Gg>.

140 Anna Feigenbaum, "White-washing the water cannon: salesmen, scientific experts and human rights abuses," *openDemocracy*, 25 February 2014, <https://www.opendemocracy.net/en/opensecurity/white-washing-water-cannon-salesmen-scientific-experts-and-human-rights/>.

141 Agence France-Presse, "Hong Kong protests: police fire water cannon with blue dye as crowds defy ban," *The Guardian*, 20 October 2019, <https://www.theguardian.com/world/2019/oct/21/hong-kong-protests-police-fire-water-cannon-with-blue-dye-as-crowds-defy-ban>.

142 Anna Feigenbaum, "White-washing the water cannon: salesmen, scientific experts and human rights abuses," *openDemocracy*, 25 February 2014, <https://www.opendemocracy.net/en/opensecurity/white-washing-water-cannon-salesmen-scientific-experts-and-human-rights/>.

143 *Id.*

144 Patrick Strickland, "Israel Sprays 'Skunk Water' into Palestinian Homes," *The Electronic Intifada*, September 22, 2014, <http://electronicintifada.net/blogs/patrick-strickland/israel-sprays-skunk-water-palestinian-homes>.

145 Sue Surkes, "Indians unfazed by Israeli-made stink bomb," *The Times of Israel*, 30 July 2017, <https://www.timesofisrael.com/indians-unfazed-by-israeli-made-stink-bomb/>; and Margarita Antidze, "In new protests, foul-smelling substance interrupts Georgian assembly," *Reuters*, 12 December 2019, <https://www.reuters.com/article/us-georgia-politics-protests/in-new-protests-foul-smelling-substance-interrupts-georgian-assembly-idUSKBN1YG1ZT>.

## Health effects

Because of the limited literature on water cannons and scarcity of medical literature on injuries, it was not possible to conduct a full systematic review of the injuries caused by water cannons. However, a review of articles identified in our systematic search of data published in secondary sources identified a number of cases of serious injury directly or indirectly caused by water cannons.

High-pressure water can cause direct injuries, such as trauma directly to the body or internal injuries from the force of the water stream.<sup>146</sup> There are a handful of case reports that describe facial injuries such as blindness or eardrum rupture from the force of the water. The blunt force of high-velocity water cannons can cause indirect injuries from forced falls into the ground or obstacles.<sup>147</sup> Case reports describe contusions,<sup>148</sup> skull fractures,<sup>149</sup> and lacerations<sup>150</sup> secondary to water cannon strikes. Occupational injuries to law enforcement officers during training included accidental musculoskeletal

injuries from close-range exposure. One article documented “reduced visual acuity bilaterally, extensive eyelid ecchymosis, subconjunctival haemorrhages, hyphema, iris sphincter rupture, transient increase in intraocular pressure” in three people with direct high-pressure water trauma to the face.<sup>151</sup>

In recent years, personal reports on social media, as well as news reports, have highlighted the inherent dangers of water cannons. There are several documented cases of bone and musculoskeletal injuries and fatalities from falls and trauma secondary to the force of the water. Since the publication of our prior report, Baek Nam-Gi, a South Korean farmer, went into a coma after being knocked over by a water cannon and died of his injuries.<sup>152</sup> In a similar case from May 2015, Chilean student Rodrigo Aviles suffered serious head injuries (subdural hematoma) after he was knocked over by water cannons fired from a distance of less than five metres. After being in a coma, Aviles finally recovered but still has seizures and

146 Dietrich Wagner, “‘People of Britain, Beware of the Water Cannon’: A Warning from Dietrich Wagner, Near-Blinded in Stuttgart,” February 21, 2014, sec. News, <http://www.telegraph.co.uk/news/uknews/law-and-order/10654956/People-of-Britain-beware-of-the-water-cannon-a-warning-from-Dietrich-Wagner-near-blinded-in-Stuttgart.html>.

147 Author redacted, “Medical Implications of the Use of Vehicle Mounted Water Cannon (Issue 2.0).”

148 See <https://twitter.com/NTarnopolsky/status/1287352851581284352>.

149 Samuel Osborne, “Woman left with fractured skull after being blasted with water cannon during Dutch lockdown riots,” *The Independent*, 29 January 2021, <https://www.independent.co.uk/news/world/europe/dutch-lockdown-riots-woman-fractured-skull-water-cannon-b1794374.html>.

150 Amnesty International, “Hong Kong: Water cannons pose real danger in hands of trigger-happy police,” *Amnesty International*, 10 August 2019, <https://www.amnesty.org/en/latest/press-release/2019/08/hong-kong-police-water-cannon-danger/>.

151 D Landau and D Berson, “High-Pressure Directed Water Jets as a Cause of Severe Bilateral Intraocular Injuries,” *American Journal of Ophthalmology* 120, no. 4 (October 1995): 542–43.

152 Phil Robertson, “South Korea Activist Dies After Water Cannon Attack,” *Human Rights Watch Dispatches*, September 29, 2016, <https://www.hrw.org/news/2016/09/29/south-korea-activist-dies-after-water-cannon-attack#>.

other health issues.<sup>153</sup> In 30 cases of injury from water cannons in Turkey, injuries varied in severity based on the pressure, distance, and duration of exposure as well as whether victims experienced collisions, falls, or being swept away by the force of the water.<sup>154</sup>

There are also several videos on social media sites documenting water cannons directly hitting people, causing them to fall, rendering them unconscious, or causing traumatic injuries.<sup>155</sup> In one notable example caught on video in 2021, a Dutch woman sustained a skull fracture and required sutures secondary to direct targeting by a water cannon, forcing her to hit a nearby concrete wall.<sup>156</sup> Years later, her case is still in the courts, and she has ongoing physical and mental disabilities.<sup>157</sup> In July 2020, a 19-year-old Israeli protester was hit by a jet of water on his head from a distance of a few metres during a mass protest against Prime Minister Benjamin Netanyahu in Jerusalem. The protester was

knocked to the floor, lost consciousness, bruised his head and his eardrum was torn.<sup>158</sup>

All water cannons douse protesters in water. In colder climates, this may cause hypothermia and frostbite; conversely, the use of scalding hot water may expose individuals to the risk of thermal injury, such as skin burns. During the 2014 Euromaidan protests in Ukraine, police employed water cannons in -10C weather,<sup>159</sup> resulting in one death<sup>160</sup> from pneumonia attributed to their use. Hypothermia was also reported when water cannons were used in subfreezing temperatures near the Standing Rock Indian Reservation in the United States<sup>161</sup> and even in milder temperatures in Hong Kong.<sup>162</sup> In Nigeria, there were reports of scalding hot water being used on demonstrators, causing several people to sustain thermal injuries and burns.

---

153 Constanza Hola Chamy, BBC Mundo, "Rodrigo Avilés, El Estudiante En Coma Por El Que Miles Se Movilizan En Chile," *BBC Mundo*, May 29, 2015, [http://www.bbc.com/mundo/noticias/2015/05/150529\\_rodrigo\\_aviles\\_estudiante\\_coma\\_chile\\_ch](http://www.bbc.com/mundo/noticias/2015/05/150529_rodrigo_aviles_estudiante_coma_chile_ch).

154 Umit Unuvar et al., "Medical Evaluation of Gezi Cases - HRFT" (Human Rights Foundation of Turkey, December 2013).

155 See above n 138.

156 Reuters, "Dutch woman bloody and injured by police water cannon at Netherlands protest," *Youtube*, 27 January 2021, <https://www.youtube.com/watch?v=79PrfqkUHqs>.

157 Tom van der Meer, "Agent die met waterstraal in gezicht van Denisa spoot tijdens rellen in Eindhoven wordt vervolgd," *ad.nl*, 15 August 2022, <https://www.ad.nl/binnenland/agent-die-met-waterstraal-in-gezicht-van-denisa-spoot-tijdens-rellen-in-eindhoven-wordt-vervolgd~a4ee86b4/>.

158 "Knesset panel debates cops' use of water cannons at anti-Netanyahu protests" *The Times of Israel*, July 28, 2020. <https://www.timesofisrael.com/knesset-panel-debates-cops-use-of-water-cannons-at-anti-netanyahu-protests/>.

159 Interfax-Ukraine, "Ukrainian govt lifts restrictions on use of water cannons against rioters in cold weather," *Interfax-Ukraine*, January 22, 2014, <https://en.interfax.com.ua/news/general/187027.html>.

160 Kyiv Post, "Protester dies of pneumonia, allegedly caused by water cannons," *Kyiv Post*, January 30, 2014, <https://www.kyivpost.com/post/9370>.

161 Derek Hawkins, "Police defend use of water cannons on Dakota Access protesters in freezing weather," *The Washington Post*, November 21, 2016, <https://www.washingtonpost.com/news/morning-mix/wp/2016/11/21/police-citing-ongoing-riot-use-water-cannons-on-dakota-access-protesters-in-freezing-weather/>.

162 Julie McCarthy, "Protesters Hunker Down Inside A Hong Kong University," *National Public Radio*, November 19, 2019, <https://www.npr.org/2019/11/19/780713458/protesters-hunker-down-inside-a-hong-kong-university>.

The addition of chemical irritants to water cannons compounds the health risks, particularly because the lack of transparency regarding the type and quantity of chemicals used can make treatment challenging. Early reports of water cannons using an “ammonia solution” in Indonesia were accompanied by reports of chemical burns, presumably as a result of these chemicals.<sup>163</sup> More recently, powdered OC in suspension and/or liquid CS has been confirmed to be used in water cannons in Chile,<sup>164</sup> Hong Kong,<sup>165</sup> Malaysia,<sup>166</sup> Thailand,<sup>167</sup> and Turkey,<sup>168</sup> among other countries. The addition of CS compound to water is particularly troubling given the propensity of the agent to cause contact chemical burns,<sup>169</sup> as has been reported in Chile<sup>170</sup> and elsewhere.

Another type of preparation used in water cannons is water mixed with malodorant compounds that are thought to be ammonia produced in the fermentation of yeast and sodium bicarbonate. Those exposed have reported nausea, vomiting, and headaches. An additional concern is that the substance often persists for several days or more, raising the risk of longer-term toxicity.<sup>171</sup> To date, there is little research on health effects specific to this substance.

---

163 Sue Lloyd-Roberts, “British arms help Jakarta fight war against its own people,” *The Independent*, March 27, 1997, <https://www.independent.co.uk/news/world/british-arms-help-jakarta-fight-war-against-its-own-people-oveyr-2-1275264.html>.

164 Ministerio del Interior y Seguridad Pública, “Circular 1832: Uso de la fuerza: actualiza instrucciones al respecto,” *Biblioteca del Congreso Nacional de Chile*, March 4, 2019, <https://www.bcn.cl/leychile/navegar?idNorma=1129442>.

165 Chan Chi-chuen, “LCQ18: Coloured water sprayed by specialised crowd management vehicles,” *The Government of the Hong Kong Special Administrative Region*, November 13, 2019, <https://www.info.gov.hk/gia/general/201911/13/P2019111300485.htm>.

166 Celine Fernandez and James Hookway, “Malaysian Police Fire Tear Gas on Protesters,” *The Wall Street Journal*, April 28, 2012, <https://www.wsj.com/articles/SB10001424052702304811304577371110260111368>.

167 Amnesty International, “Thailand: ‘My face burned as if on fire’: Unlawful use of force by Thailand’s police during public assemblies,” *Amnesty International*, July 2, 2021, <https://www.amnesty.org/en/documents/asa39/4356/2021/en/>.

168 Hurriyet Daily News, “14 tons of water mixed with tear gas used in May Day crackdown by Istanbul police,” *Hurriyet Daily News*, May 26, 2013, <https://www.hurriyetaidailynews.com/14-tons-of-water-mixed-with-tear-gas-used-in-may-day-crackdown-by-istanbul-police-47656>.

169 Tsang et al., “Health risks of exposure to CS gas (tear gas): an update for healthcare practitioners in Hong Kong,” *Hong Kong Medical Journal* 26, no. 2 (April 2020): 151-3 <https://www.hkmi.org/abstracts/v26n2/151.htm>.

170 Daniela Silva, “Expertos advierten en comisión de DD.HH. del Senado que carro lanzaguas está provocando graves quemaduras a manifestantes: ‘Si afectan a un niño o a un adulto mayor, pueden ser mortales,’” *La Tercera*, December 9, 2019, <https://www.latercera.com/nacional/noticia/expertos-advierten-comision-dd-hh-del-senado-carro-lanza-agua-esta-provocando-graves-quemaduras-manifestantes-afecta-nino-adulto-menor-pueden-mortales/931860/>.

171 Anne Suci, “Ending the Use of Skunk Spray in East Jerusalem,” 24 November 2011, <http://www.acri.org.il/en/wp-content/uploads/2015/05/EJ-Skunk-Spray-Letter-Nov-14.pdf>.



## Sidebar

## Supreme Court ruling on “skunk water’ in Israel

In August 2020, the Supreme Court of Israel made a ruling on one of the most notorious types of water cannon, which fires so-called “skunk water,” which has been used in Israel and reportedly is now being used in several other countries. Skunk water was developed by an Israeli company. It was first used against Palestinian protesters in the occupied territories, and since 2015 the Israeli police have used it mainly against Palestinian protesters in East Jerusalem and ultra-Orthodox Jewish protesters in Jerusalem. Its use in dense residential neighbourhoods leaves entire communities- shops, houses, streets - awash in a horrible, overpowering smell for several days. The smell has been described as the smell of sewage mixed with rotting corpses.

The Supreme Court heard a case brought by people who were either hit by skunk water while protesting or who run shops or live in

houses next to protest areas that were filled with the odour of skunk water. The Court ruled that: “[t]he petition and the evidence attached to it presented a disturbing picture of the situation regarding the use of the skunk as a means of dispersing demonstration. . . . In particular, there seemed to be difficulty with the police spraying skunk on narrow, crowded residential streets, in a way that may cause significant damage to parties who are not involved in the demonstration at all.”

Unfortunately, the petition did not lead to a ban on the use of skunk water in residential areas, but only to its limitation. The police revised regulations limiting the use of skunk water in residential areas, “only after considering the effects of its operation on an innocent population and the possible environmental damage to be caused.”<sup>172</sup>

---

172 High Court of Justice 5882/18, *Kroiss v Israel's Police* (19.8.2020).

While evidence on the health impacts of water cannons suggests the possibility of serious injury, there are also significant practical, legal, and human rights concerns. Practically, the water cannon is a truck-mounted machine operated from inside a closed, elevated cab, making it difficult to communicate with protesters, hear their responses, and assess imminent danger.<sup>173</sup> The imposing size and shape of water cannons may intimidate protesters, perhaps purposefully, causing increased panic and, potentially, stampedes.<sup>174</sup> Because the vehicles are large, the use of multiple vehicles at once can also block roadways and deter demonstrators from egress. Water cannons are inherently indiscriminate, particularly at longer distances. The added collective punishment of utilising chemical irritants, coloured dyes, ultraviolet marker pigments, or malodorants only serves to highlight the potential for abuse of water cannons. In the context of a public demonstration, this large weapon cannot be used discriminately against disruptive individuals and has a high likelihood of harming bystanders. (For specific recommendations on water cannons, see the Recommendations Section.

## What has changed?

In recent years, the use of water cannons has expanded in many countries around the world, as has the number of reported cases of injuries. The use of malodorants, dyes and chemical irritants also appears to be expanding beyond the few countries that used these measures in our 2016 report. The rise of Twitter and other social media platforms has facilitated greater awareness of the use of water cannons and the damage they can do, including through videos and other testimonies coming directly from victims. Although it is possible that greater awareness may lead to great opprobrium and increased regulation of water cannons, for now, their use appears to be growing unchecked.

In recent years, the use of water cannons has expanded in many countries around the world, as has the number of reported cases of injuries. The use of malodorants, dyes and chemical irritants also appears to be expanding beyond the few countries that used these measures in our 2016 report.

173 Reuters, "Around the World; Frankfurt Police Charge Crowd at Banned Protest," *The New York Times*, October 6, 1985, sec. World, <http://www.nytimes.com/1985/10/06/world/around-the-world-frankfurt-police-charge-crowd-at-banned-protest-crowd.html>.

174 "Stampede in Cambodia Kills Hundreds, Government Says," accessed October 23, 2015, <http://www.cnn.com/2010/WORLD/asiapcf/11/22/cambodia.festival.deaths/index.html?hpt=T2>.

## Case study

## Long-term ocular injuries from water high pressure cannons

### Honduras

On 15 September 2020, Independence Day in Honduras,<sup>175</sup> a massive demonstration called by trade unions, students and other sectors of society gathered in Tegucigalpa's Central Park to protest against corruption and mismanagement of public funds with regard to the COVID-19 pandemic. The demonstrators intended to read a proclamation against the policies of the then president Juan Orlando Hernández. They also demanded to know what had happened to the five young Afro-descendants that had disappeared three months before. The National Police fired tear gas canisters at demonstrators and used water cannons to disperse the crowd.

The Office of the United Nations High Commissioner for Human Rights in Honduras condemned the use of force against citizens by the police. It found that these actions constituted a violation of fundamental rights in the midst of a suspension of constitutional guarantees dictated in Honduras by the then President Juan Orlando Hernández, who had established a state of emergency and a curfew in the whole country. This decree nullified guarantees as broad as freedom of thought, freedom of movement, and freedom of association, allowing the State to detain citizens for an indefinite period of time and to search private homes.

Several protesters were injured during the repression and had to be taken to the hospital. Among them was Cristian Espinoza, a 26-year-old artist who was hit in the eyes by a jet of high-pressure water mixed with chemicals.

Cristian testified in court that while he was in the park, the police began to break up the demonstration. Some demonstrators responded by throwing stones at police officers, while people were being arrested and others started running away. Cristian was trapped at the center of the park; he moved back looking for a way out and then saw a blue water cannon tank with tinted windows. The water cannon fired a jet of high-pressure water at him. The water hit him violently in the eyes and detached his eyelids. The pressure was so strong that he lost sight and fell to the ground. Some people came to his aid and carried him on their backs when Cristian fainted. He regained consciousness in the emergency room of the Hospital Escuela Universitario (HEU), where he was told that the retina of his right eye was detached, and that he would need surgery to have both eyelids repaired.

175

See <https://www.dw.com/es/honduras-onu-condena-violencia-en-manifestaci%C3%B3n-social/a-54940397>.



CRISTIAN ESPINOZA UNDERWENT SEVERAL SURGERIES DUE TO THE EYELID AND RETINA INJURIES SUSTAINED FROM A WATER CANNON BLAST TO THE FACE DURING THE SEPTEMBER 2020 ANTI-GOVERNMENT PROTESTS IN TEGUCIGALPA, HONDURAS. PHOTO COURTESY OF COMITÉ DE FAMILIARES DE DETENIDOS DESAPARECIDOS EN HONDURAS (COFADEH)

The first surgery took place that same night. Espinoza remained in hospital for eight days due to the severity of his eye injuries which almost rendered him blind. In the following months, he went through a difficult recovery; his vision was affected both by artificial light and sunlight, and he suffered strong headaches. This prevented him from working as a craftsman and circus performer. He underwent two more surgeries to recover his sight.

Cristian points out that he was always committed to political activism, but that after what happened in 2020, on that September day, everything changed; it was not just him who was affected, but also his family, mainly his mother.



# DISORIENTATION DEVICES

SMOKE RISES AS POLICE CLASH WITH PROTESTERS DURING A BLACK LIVES MATTER PROTEST NEAR THE SEATTLE POLICE EAST PRECINCT HEADQUARTERS ON JULY 25, 2020. TED S. WARREN | AP PHOTO

## Weapon profile

The UN considers “disorientation or distraction devices” as bomb-like instruments designed to daze or warn groups or individuals through some combination of noise, light, overpressure, or fragmentation.<sup>176</sup> Common names for handheld weapons of this class include stun grenades, flash-bang grenades, blast balls, sting-ball grenades, stinger grenades, lasers, or concussion grenades.

Flash-bang explosive devices were initially developed by the British Special Air Service in the 1960s and have been used for military

combat training for decades.<sup>177</sup> The first documented use of these devices outside of training was at Entebbe, Uganda in 1976, when the Israeli army used them in efforts to rescue hostages.<sup>178</sup> They were used in 1977 in Mogadishu, Somalia, and at a siege of the Iranian embassy in London in 1980.<sup>179</sup> The transition from military operations to police use occurred slowly over time. Use in urban settings and on civilian populations altered how the weapons were used, as well as the resulting injuries. Specialised law enforcement agencies like Special Weapons and Tactics (SWAT) initially developed similar weapons to use in hostage situations.<sup>180</sup>

---

176 UN Guidance on LLWs above n 6.

177 “Flash Bang Stun Grenades and Their Use in Boston: What You Need to Know,” accessed May 7, 2015, <http://thebostonmarathonbombings.weebly.com/flash-bang-stun-grenades-and-their-use-in-boston-what-you-need-to-know.html>; Steve James, “Flash Bang 101,” Sponsored by TASER INTERNATIONAL, *PoliceOne*, (October 21, 2005), <http://www.policeone.com/police-products/tactical/tactical-entry/articles/120100-Flash-Bang-101/>

178 Steve James *id.*

179 *Id.*

180 Abbie Nehring et al., “‘Less Lethal’ Flash-Bangs Used in Ferguson Leave Some Feeling the Burn,” *ProPublica*, accessed January 15, 2016, <http://www.propublica.org/article/less-lethal-flash-bangs-used-in-ferguson-leave-some-feeling-the-burn>.



The use of stun grenades in crowd control has increased significantly over the past several years, and now these weapons are manufactured by dozens of companies worldwide. They are frequently used alongside other weapons, such as chemical irritants and/or projectiles. With poor regulation and almost no quality control, defective and misfiring stun grenades have been identified in several settings where there were limited regulations or guidelines on use.<sup>181</sup>

## Mechanism of action

Flash-bang or stun grenades are usually constructed like a conventional grenade, with an explosive powder that ignites when struck by a fuse. These devices typically generate noise and a bright flash by the rapid oxidation of a pyrophoric metal, such as magnesium or aluminium; this process can generate temperatures in excess of 3,000 degrees Celsius. Some devices generate sound that has been measured in excess of 178 decibels (dB), at least ten times louder than most gunshots. Both the flash and the bang usually last less than one second, momentarily activating photoreceptor cells in the eye and causing blindness for about five seconds until the eye restores itself to its normal, unstimulated state. The loud blast causes temporary loss of hearing and of balance and generates a sense of disorientation. The concomitant blindness, hearing loss, and disorientation can result in falls. Moreover, groups of people simultaneously experiencing these symptoms can result

in panic. With concomitant use of other weapons, stampedes have been reported.<sup>182</sup>

Dazzling lasers are a subset of distraction devices that are designed to use laser or LED lights at long-range distances (1000 metres in light, 3000 metres in the dark) to temporarily disrupt vision. Dazzling laser weapons can be rifle-shaped, baton-shaped, or mounted onto other weapons. Even brief exposures (especially at close range) can result in temporary blindness and, in some cases, long-term vision loss, headaches, blurred vision, and sensitivity to light.

When distraction devices detonate, the case ruptures with significant force, so individuals standing near an explosion may suffer traumatic injury from the resulting pressure. The case can also rupture in such a way that high-velocity metal or plastic fragments are



*Examples of disorientation devices. Robin Ballantyne | Omega Research Foundation*

181 Kaye Beach, "Stun Grenades," *AxXiom for Liberty*, September 15, 2009, <https://axiomamuse.wordpress.com/tag/stun-grenades/>.

182 Steve James, "Flash Bang 101" above n 177.

sent in multiple directions. These fragments are often unevenly distributed in size, shape, and direction and can pose a generalised hazard to anyone nearby.<sup>183</sup> In addition to the shrapnel risk posed by fragmentation of the device casing, some devices are designed to deliberately scatter high-velocity rubber or plastic projectiles around the blast radius. Finally, projectiles with disorienting characteristics can be direct-fired at individuals, carrying with them similar risks as KIPs.

Given the lack of regulation of these weapons internationally, defective or poor-quality weapons are reported frequently. These weapons can explode spontaneously or have more dangerous components that can spark fires and cause severe injuries.

## Health effects

Stun grenades are—as explosive devices—by nature indiscriminate. When they are used either as distraction devices to facilitate entry or as means of crowd dispersal, the limited control users have over their placement may expose unintended targets to the risk of serious injury. A 2015 report documented more than 50 cases of severe injuries and deaths from the use of stun grenades since 2000 in the U.S.<sup>184</sup> When used indoors or in dense crowds, these risks are amplified and can create additional hazards through fires as well as psychological panic they may provoke.

As with all explosives, stun grenades carry the risk of blast injury. These injuries are complex and result from pressure waves created by

Type of Blast Injury	Cause	Outcome
Primary blast injury	Supersonic pressure shock waves from the blast.	Internal injuries, especially of delicate membranes like the eardrum and the lung membranes.
Secondary blast injury	Explosion and fragmentation of objects.	Blunt and penetrating trauma from explosive devices.
Tertiary blast injury	Displacement of air causes blast wind that can push people into solid objects.	Blunt and penetrating trauma, including fractures and head trauma.
Quaternary blast injury	Miscellaneous injuries caused by other parts of the explosion.	Burns, respiratory injuries from flames and smoke, crush injuries, eye injuries, psychiatric trauma (PTSD).

Figure 11: Blast injury.

183 Charlie Mesloh et al., "An Exploratory Study of Stingball Grenades," *Florida Gulf Coast University*, Report Number 2009-DI-BX-K008, 2011, [https://www.researchgate.net/publication/263808368\\_An\\_Exploratory\\_Study\\_of\\_Stingball\\_Grenades](https://www.researchgate.net/publication/263808368_An_Exploratory_Study_of_Stingball_Grenades).

184 Julia Angwin, Abbie Nehring, and ProPublica, "Hotter Than Lava: Every Day, Cops Toss Flashbang Grenades With Little Oversight and Horrifying Results," *ProPublica*, accessed May 13, 2015, <http://www.propublica.org/article/flashbangs>.

## The use of stun grenades for crowd control is an example of the inappropriate, inadequately regulated use of military weapons for crowd management.

the blast. Blast injuries from close proximity explosions can lead to internal haemorrhage, eardrum rupture, lung injury, amputation, fractures, and degloving injuries (extensive skin removal that exposes underlying tissue). In 2011, a U.S. SWAT officer died of internal bleeding when a stun grenade exploded in his hand while he was checking it.<sup>185</sup> A French activist was killed in 2014 by an OF-F1 “blast-ball” style grenade—a weapon now prohibited in France—when it detonated after becoming lodged between his jacket and backpack.<sup>186</sup> During the George Floyd protests in Seattle, United States, a woman went into cardiac arrest after being hit in the chest with a “blast-ball” style hybrid projectile that combined a concussive detonation with chemical irritants.<sup>187</sup>

In addition to injuries caused directly by the primary blast wave, such as ear-drum rupture or lung injury, secondary and tertiary injuries can also occur as a result of these explosive devices. All weapons are made of both metal

and plastic parts that may fragment during the explosion and act as shrapnel. Some weapons, such as “sting-ball” grenades, are specifically designed to fragment and forcefully eject shrapnel across the blast area. These weapons behave as KIPs in terms of ballistics but are incapable of being aimed, resulting in weapons that are both completely indiscriminate and impossibly imprecise. Serious injuries have been documented from these unaimed impact projectiles.<sup>188</sup> These include penetrating injury, skull fracture, severe ocular trauma, and enucleation.<sup>189</sup> Tertiary injuries occur from being thrown on the ground by their force, and quaternary injuries result from fires and other results of the blast.

Stun grenades burn extremely hot and can cause life-threatening thermal injuries. A 2015 report by ProPublica, summarised in our first *Lethal in Disguise* report, identified more than 50 people seriously injured or killed by stun grenades since 2000, with

185 Daily Mail Reporter, “Veteran SWAT Officer Killed in His Home after Stun Grenade He Was Safety-Checking Explodes,” *Daily Mail*, February 26, 2011, <http://www.dailymail.co.uk/news/article-1361010/Veteran-SWAT-officer-killed-home-stun-grenade-safety-checking-explodes.html>.

186 AFP, “Mort de Rémi Fraisse: la Cour de cassation confirme le non-lieu en faveur du gendarme,” *Le Point*, March 23, 2021, [https://www.lepoint.fr/societe/mort-de-remi-fraisse-la-cour-de-cassation-confirme-le-non-lieu-en-faveur-du-gendarme-23-03-2021-2419009\\_23.php](https://www.lepoint.fr/societe/mort-de-remi-fraisse-la-cour-de-cassation-confirme-le-non-lieu-en-faveur-du-gendarme-23-03-2021-2419009_23.php).

187 Liz Jones and Isolde Raftery, “This woman ‘died three times’ after Seattle Police hit her with a blast ball,” *KUOW*, June 10, 2020, <https://www.kuow.org/stories/this-26-year-old-died-three-times-after-police-hit-her-with-a-blast-ball>.

188 Aurore Chauvin et al., “Ocular injuries caused by less-lethal weapons in France,” *The Lancet* 394, no. 10209 (November 2019): 1616-1617 [https://www.thelancet.com/journals/lancet/article/PIIS0140-6736\(19\)31807-0/fulltext](https://www.thelancet.com/journals/lancet/article/PIIS0140-6736(19)31807-0/fulltext).

189 V Scolan et al., “Risks of non-lethal weapon use: case studies of three French victims of stinger grenades,” *Forensic Science International* 223, (212): e18-21 <https://pubmed.ncbi.nlm.nih.gov/22981215/>.

## Stun grenades are—as explosive devices—by nature indiscriminate.

thermal injury being the primary mechanism of injury.<sup>190</sup> Furthermore, stun grenades can cause fires in structures; these fires have led to fatalities.<sup>191</sup> Defective and poorly designed weapons may play a role in injury severity.<sup>192</sup> In one notable case from 2014 that illustrates the complexity of injuries arising from stun grenades: after a stun grenade was thrown into his crib during a raid of his home, an 18-month-old boy sustained a chest wound so deep it exposed his ribs. He also suffered third-degree burns that required him to be placed in a medically induced coma, endure weeks of ICU-level care, and undergo numerous skin grafting surgeries.<sup>193</sup>

In addition to the risks associated with their blast, some distraction devices are designed to be fired from grenade launchers or similar platforms. When aimed (inappropriately) at individuals, the blast risk is compounded by the kinetic risk of what is essentially

an improvised KIP. In Portland, US, two individuals were severely injured in 2018 by “airborne warning/signalling munitions” fired by police directly at protesters. One suffered a traumatic brain injury after being shot in the back of the head with such a round,<sup>194</sup> while another suffered third-degree burns and impact wounds after being shot in the chest and arm.<sup>195</sup> Concerns about direct-fire injuries also have been raised following numerous reported accounts from Colombia of the Venom system being used in a direct-fire capacity with stun grenades.<sup>196</sup>

The use of stun grenades for crowd control is an example of the inappropriate, inadequately regulated use of military weapons for crowd management. While the stated objective of stun grenades is to cause disorientation and a temporary sense of panic, the potential for severe blast injuries and even death caused by the pressure of the blast or by shrapnel from the fragmentation of plastic and metal constituents of the grenade is disproportionately high. The blinding light and deafening sound they produce can also cause injuries indiscriminately.

190 Julia Angwin, Abbie Nehring, and ProPublica, “Hotter Than Lava: Every Day, Cops Toss Flashbang Grenades With Little Oversight and Horrifying Results,” *ProPublica*, accessed May 13, 2015, <http://www.propublica.org/article/flashbangs>.

191 KSBW, “Monterey County to pay Greenfield family \$2.6 million for father’s flash-bang death,” *KSBW*, August 19, 2013, <https://www.ksbw.com/article/monterey-county-to-pay-greenfield-family-2-6-million-for-father-s-flash-bang-death/1052306#>.

192 Julia Angwin, Abbie Nehring, and ProPublica, “Hotter Than Lava: Every Day, Cops Toss Flashbang Grenades With Little Oversight and Horrifying Results,” *ProPublica*, accessed May 13, 2015, <http://www.propublica.org/article/flashbangs>.

193 Alison Lynn and Matthew Gutman, “Family of Boy Injured by ‘Grenade’ Has \$1M in Medical Bills,” *ABC News*, December 22, 2014, <http://abcnews.go.com/US/family-toddler-injured-swat-grenade-faces-1m-medical/story?id=27671521>.

194 Shane Dixon Kavanaugh, “‘It felt like a war zone’: Portland protester hit in head by police flash-bang speaks,” *Oregon Live*, August 11, 2018, [https://www.oregonlive.com/portland/2018/08/it\\_felt\\_like\\_a\\_war\\_zone\\_portla.html](https://www.oregonlive.com/portland/2018/08/it_felt_like_a_war_zone_portla.html).

195 J Wilson, “Woman says she was permanently disfigured by Portland police at protest,” *The Guardian*, August 5, 2019, <https://www.theguardian.com/us-news/2019/aug/05/portland-police-protests-woman-claims-disfigured>.

196 Chloé Lauvergnier, “Protests in Colombia: Videos show ‘dangerous’ use of grenade launchers by police,” *France 24*, May 24, 2021 <https://observers.france24.com/en/americas/20210526-colombia-police-protests-venom-grenade-launchers>.

## What has changed?

- › Fragmentation injuries: Since 2016, there has been a growing recognition of the hazards posed by the shower of fragmented pieces from distraction devices. Upon detonation, distraction devices may—unintentionally or by design—disperse dozens of metal or plastic shards as shrapnel in a spherical radius without any control of what they hit. Each fragment behaves, in effect, as a kinetic impact projectile, with one crucial difference: the user of the distraction device has no more than the most rudimentary control of the trajectory of these projectiles. These weapons are, therefore, fundamentally indiscriminate impact weapons when used in the context of crowd control.
- » Severe kinetic injuries from distraction devices, including amputation and loss of sight, have been recorded in the medical literature over the last decade in France,<sup>197</sup> both before and

after the Yellow Vests protests. Fragmentation injuries from stun grenades used to disperse the Gezi Park protests were also reported in the medical literature in Turkey.<sup>198</sup> During the Euromaidan protests in Ukraine, at least 133 individuals suffered traumatic injuries as a result of stun grenade usage, mostly because of the fragmentation of the weapons.<sup>199</sup> In the United States, stun grenades were widely used during the George Floyd protests, resulting in numerous injuries.<sup>200</sup>

- › Multiple stun grenade launchers: A worrisome trend in weapons research and development is “area-effect” stun grenades and delivery systems designed to project multiple bomblets across great distances. The commercial Venom multiple-launch system has already been restricted by a court<sup>201</sup> order in Popayán, Colombia, over concerns about the indiscriminate nature of the unaimed projectiles.<sup>202</sup>

197 V Scolan et al., “Risks of non-lethal weapon use: case studies of three French victims of stinger grenades,” *Forensic Science International* 223, (212): e18-21 <https://pubmed.ncbi.nlm.nih.gov/22981215/>.

198 Umit Unuvar et al., “Usage of Riot Control Agents and other methods resulting in physical and psychological injuries sustained during civil unrest in Turkey in 2013,” *Journal of Forensic and Legal Medicine* 45 (2017): 47-52 <https://www.sciencedirect.com/science/article/abs/pii/S1752928X16301573>.

199 VD Mishalov et al., “Forensic assessment of gunshot injuries in Maidan Nezalezhnosti protesters,” *World of Medicine and Biology* 69, no. 3 (2019): 118-122, <https://womab.com.ua/en/smb-2019-03/8015>.

200 Sonoma County Commission on Human Rights, “Human Right Violations in Santa Rosa California Policing the Black Lives Matter Protests,” *Sonoma County Commission on Human Rights*, July 2020, <https://srcity.org/DocumentCenter/View/32184/Report-BLM-Human-Rights-Abuses-July2020>; and Lewis Kamb, “Seattle police continue to use ‘flash-bang’ grenades during protests, despite recommendations,” *The Seattle Times*, August 12, 2020, <https://www.seattletimes.com/seattle-news/seattle-police-continue-to-use-flash-bang-grenades-during-protests-despite-recommendations/>.

201 Juzgado Décimo Administrativo Mixto de Oralidad Circuito de Popayán No. 065 de 2021, file 19001-33-33-010-2021-00085-00 ACUMULADO AL PROCESO 1900133-33-010-2021-000089-00, 2 June 2021, pp. 35 and 36.

202 MF Romoleroux, “Juez ordena al Esmad no hacer uso del arma Venom en Popayán,” *El Tiempo*, June 4, 2021, <https://www.eltiempo.com/colombia/otras-ciudades/juez-ordena-a-esmad-no-usar-arma-venom-en-popayan-593528>.



Meanwhile, the United States Defense Department is developing a “non-lethal indirect fire munition” fired from an 81-mm mortar that would disperse multiple flash-bang bomblets over a kilometre away.<sup>203</sup> Similar to outlawed cluster munitions, the flash-bang mortar represents a disturbing trend towards greater and more indiscriminate use of these weapons, in spite of mounting evidence of their potential harm.

- › Growth of combined weapons: Blast balls are a type of hybrid stun grenade combining bright lights and loud sounds with chemical irritants. Blast ball grenades are similar to so-called “sting-ball” or “stinger” grenades that combine a flash-bang capability with a load of pellets designed to disperse randomly from the point of deflagration. Blast balls, however, replace the pellets with CS agents. Unlike many distraction devices, which function primarily through the ignition of a pyrotechnic metal and are not designed to fragment, these grenades, by nature, are designed to explode to release the irritant or KIPs. Stinger grenades and blast balls, therefore, carry an inherent risk of generating shrapnel upon deflagration, possibly dispersing a shower of sharp, irregular projectiles around the detonation site. This hybrid weaponry poses specific health risks: chemical burns and traumatic injuries combined with explosive injuries can be painful, debilitating, and challenging to treat.

---

203 Kyle Rempfer, “Marines ‘hang’ flash-bang mortar rounds for first time,” *Marine Corps Times*, July 18, 2018, <https://www.marinecorpstimes.com/news/your-military/2018/07/18/marines-hang-flash-bang-mortar-rounds-for-first-time/>.

## Case study

## Deaths and maimings from explosive stun grenades

 France

The French police and gendarmerie (military police) frequently use explosive grenades for crowd control. Unlike many “flash-bang” grenades, which generate light and noise without rupturing the grenade case, these grenades carry an explosive charge that creates a violent blast upon deflagration. Numerous cases of severe injuries associated with these grenades have led to a reconsideration of their use in crowd control.

The “OF-F1” offensive stun grenade was first deployed in the 1970s,<sup>204</sup> and as early as 1977 the grenade, which contains TNT, was implicated in the death of a protester.<sup>205</sup> Its use was brought to national attention in 2014, when one such grenade fired by a gendarme killed an environmental protester

at the proposed Sivens dam site.<sup>206</sup> Their use, as well as the use of other high-explosive “offensive grenades,” was subsequently banned in France.<sup>207</sup>

However, similar weapons remain in use under the moniker of “defensive” grenades. The GLI-F4 exploding tear gas grenade was extensively used during the Yellow Vests protests of 2018 and 2019. This “hybrid” weapon combines a concussive blast produced by TNT with a payload of CS agent. It is allegedly responsible for at least 30 injuries (including five disabling hand injuries) during the Yellow Vests protests.<sup>208</sup> The GLI-F4 was withdrawn from use in early 2020,<sup>209</sup> although concerns persist about its successor<sup>210</sup> (the GM2L defensive grenade), which substitutes

204 Jean-Louis Courtois, “Le retrait de la grenade OF F1: Bonne ou mauvaise idée?” *L'Essor de la Gendarmerie Nationale*, 2017, <https://web.archive.org/web/20181208132326/https://lessor.org/wp-content/uploads/2017/07/grenade-OF-F1.pdf>.

205 Louise Fessard, “Grenades offensives: enquête sur le précédent de Creys-Malville en 1977,” *Mediapart*, 17 December 2014, <https://www.mediapart.fr/journal/france/171214/grenades-offensives-enquete-sur-le-precedent-de-creys-malville-en-1977>.

206 Le Monde, “Mort de Rémi Fraisse: six ans après, le non-lieu confirmé pour le gendarme qui a tiré la grenade,” *Le Monde*, 23 March 2021, [https://www.lemonde.fr/societe/article/2021/03/23/mort-de-remi-fraisse-la-cour-de-cassation-confirme-le-non-lieu-en-faveur-du-gendarme\\_6074170\\_3224.html](https://www.lemonde.fr/societe/article/2021/03/23/mort-de-remi-fraisse-la-cour-de-cassation-confirme-le-non-lieu-en-faveur-du-gendarme_6074170_3224.html).

207 MINISTÈRE DE L'INTÉRIEUR, “Décret no 2017-1029,” *Journal officiel de la République Française*, 10 May 2017, no. 0110, [https://www.legifrance.gouv.fr/download/pdf?id=q7JUH89szWx\\_8vz2eKWlaxePHm3gxbQ9XWraqEbQhRg=](https://www.legifrance.gouv.fr/download/pdf?id=q7JUH89szWx_8vz2eKWlaxePHm3gxbQ9XWraqEbQhRg=).

208 Amnesty International, “France: Call for suspending the use of rubber bullets fired with the LBD40 and for banning grenades GLI-F4 in the context of policing protests,” *Amnesty International*, 3 May 2019, <https://www.amnesty.org/en/wp-content/uploads/2021/05/EUR2103042019ENGLISH.pdf>.

209 Agence France Presse, “France withdraws controversial grenade from police use,” *France24*, 26 January 2020, <https://www.france24.com/en/20200126-france-withdraws-controversial-grenade-from-police-use>.

210 “Question écrite n° 14458 de Mme Laurence Cohen,” *senat.fr*, 27 February 2020, p. 954, <https://www.senat.fr/questions/base/2020/qSEQ200214458.html>.

RÉMI FRAISSE AT THE PROTEST AGAINST THE SIVENS DAM PROJECT ON OCTOBER 25, 2014, FRANCE. CREATIVE COMMONS/WIKIPEDIA



TNT for black powder yet still operates as an explosive device.<sup>211</sup> Within a year of being put into use, serious injuries have already been reported from the GM2L.<sup>212</sup>

In regular use throughout this time period have been so-called “de-encirclement” grenades, known as “DBD” or “DMP,” which are explicitly designed to explode and project small rubber fragments across its blast radius.<sup>213</sup> These fragments act as multi-projectile KIPs that cannot be aimed,

resulting in a highly indiscriminate weapon. In 2016, one civilian suffered severe head trauma<sup>214</sup> and another lost an eye<sup>215</sup> to injuries with a de-encirclement grenade thrown by Paris police. Further reports of injuries from “sting-ball” grenades during the Yellow Vests protests—including a demonstrator who lost four fingers<sup>216</sup>—are consistent with this weapon profile.

211 Caroline Piquet, “Retrait de la grenade GLI-F4: la GM2L est-elle moins dangereuse?” *Le Parisien*, 27 January 2020, <https://www.leparisien.fr/faits-divers/retrait-de-la-grenade-gli-f4-la-gm2l-est-elle-moins-dangereuse-27-01-2020-8245689.php>.

212 Amnesty International, “France: Abusive and illegal use of force by police at Redon rave highlights need for accountability,” *Amnesty International*, 14 September 2021, <https://www.amnesty.org/en/latest/news/2021/09/france-abusive-and-illegal-use-of-force-by-police-at-redon-rave-highlights-need-for-accountability/>.

213 Maxime Davoust, “Manifestation à Paris : Alsetex a fabriqué les grenades de ‘désencerclement,’” *Les Nouvelles*, 18 June 2020, [https://actu.fr/pays-de-la-loire/precigne\\_72244/manifestation-a-paris-alsetex-a-fabrique-les-grenades-de-desencerclement\\_34369970.html](https://actu.fr/pays-de-la-loire/precigne_72244/manifestation-a-paris-alsetex-a-fabrique-les-grenades-de-desencerclement_34369970.html).

214 Paul Conge, “Romain D. grièvement blessé: faut-il interdire les grenades de désencerclement?,” *L’Express*, 7 June 2016, [https://www.lexpress.fr/actualite/societe/romain-d-grievement-blesse-faut-il-interdire-les-grenades-de-desencerclement\\_1799886.html](https://www.lexpress.fr/actualite/societe/romain-d-grievement-blesse-faut-il-interdire-les-grenades-de-desencerclement_1799886.html).

215 Greg Sandoval, “I saw a man lose his eye to a ‘less-lethal’ police weapon,” *The Verge*, 22 September 2016, <https://www.theverge.com/2016/9/22/13022262/laurent-theron-paris-protest-police-crowd-control-weapons>.

216 Peter Stubley, “Yellow vest demonstrator injured by grenade as protesters try to storm French National Assembly,” *The Independent*, 9 February 2019, <https://www.independent.co.uk/news/world/europe/yellow-vest-protests-paris-police-grenade-sting-ball-national-assembly-gilets-jaunes-macron-a8771701.html>.

## Case study

## Dangers of shrapnel from blast-balls in Seattle

 United States

Police in Seattle, Washington, US, have made extensive use of “blast balls.”<sup>217</sup> These are a type of hybrid distraction device that combines the explosive lights and sounds of flash-bang grenades with tear gas grenades.<sup>218</sup> While these grenades are not explicitly advertised as fragmentation devices, shrapnel generated by their detonation has been implicated in a number of injuries dating back to 2016, including a journalist struck in the face<sup>219</sup> and several other persons injured during the George Floyd protests of 2020.<sup>220</sup>

In June of 2020, the Seattle City Council voted unanimously to prohibit the use of many CCWs for protest, including blast balls.<sup>221</sup> A court ruling later found the Seattle Police Department in contempt of court for violating the prohibition.<sup>222</sup> In the order, U.S. District Judge Richard Jones expressed special concern over the indiscriminate and imprecise nature of blast balls and the risk they pose to peaceful demonstrators, noting that several violations of the prohibition represented use that was either indiscriminate or disproportional.<sup>223</sup>



DEMONSTRATORS CLASH WITH POLICE NEAR THE SEATTLE POLICE DEPARTMENTS EAST PRECINCT ON JUNE 7, 2020 IN SEATTLE, WASHINGTON. EARLIER IN THE EVENING, A SUSPECT DROVE INTO THE CROWD OF PROTESTERS AND SHOT ONE PERSON, WHICH HAPPENED AFTER A DAY OF PEACEFUL PROTESTS ACROSS THE CITY. LATER, POLICE AND PROTESTERS CLASHED VIOLENTLY.  
DAVID RYDER | GETTY IMAGES

217 Amy Radil, “Blast balls and projectiles: Seattle police have a history of crowd control criticism,” *KUOW*, June 26, 2020, <https://www.kuow.org/stories/unanswered-letters-buried-reports-critics-say-spd-response-on-crowd-control-is-overdue>.

218 Spec sheet on the “blast balls” used by Seattle PD: <https://www.lesslethal.com/product-specifications?task=document.viewdoc&id=109>.

219 KOMO News Staff, “Man files suit against city over injury suffered during Seattle May Day protests,” *KOMO News*, August 16, 2016, <https://komonews.com/news/local/man-files-lawsuit-against-city-of-seattle-over-injury-suffered-during-may-day-protests>.

220 See in particular Seattle Office of Police Accountability reports 2020 OPA-0335, 2020 OPA-0344, 2020 OPA-0492, and 2020 OPA-0495: <https://www.seattle.gov/opa/case-data/demonstration-complaint-dashboard>.

221 <https://council.seattle.gov/2021/01/22/faq-ban-on-seattle-police-use-of-tear-gas-pepper-spray-blast-ball-other-crowd-control-weapons/>.

222 Angela King and Dyer Oxley, “Seattle police found in contempt of court over use of pepper spray, blast balls,” *KUOW*, December 8, 2020, <https://www.kuow.org/stories/seattle-police-found-in-contempt-of-court-over-use-of-pepper-spray-blast-balls>.

223 See <https://publicola.com/wp-content/uploads/2020/12/order-12-7-20.pdf>.



# ACOUSTIC WEAPONS

PROTESTERS PLUG THEIR EARS SEPTEMBER 24, 2009 AS POLICE USE A SONIC WEAPON AGAINST AN UNPERMITTED PROTEST MARCH THAT BEGAN AT ARSENAL PARK IN LAWRENCEVILLE DURING THE G-20 SUMMIT. MICHEAL HENNINGER | © PITTSBURGH POST GAZETTE, 2016, ALL RIGHTS RESERVED.

## Weapon profile

Acoustic or sonic weapons (also known as long-range acoustic devices, sound cannons, hailing devices, sonic bullets, and noise bazookas) are devices that deliver very loud sounds over long distances. They can be designed to deliver painful audible or inaudible sound waves or to act more like very loud voice amplifiers to deliver voice messages or other sounds.

This technology has been used for crowd-control purposes since the early 1990s. It was originally developed by the LRAD (Long Range Acoustic Device) Corporation.<sup>224</sup>

Several other companies, including Hyperspike, now sell the weapons as well.<sup>225</sup> According to the LRAD Corporation, these weapons are sold to police departments in more than 100 countries.<sup>226</sup>

The LRAD brand weapon has a range of 8,900 metres for intelligible speech and a maximum output of 162 decibels (dB) at one metre and can cause pain (110 – 130 dB) at 20 metres.<sup>227</sup>

A different form of acoustic weapon emits very high-pitched sounds that are audible and painful to younger people (teenagers and those in their 20s), while leaving older people (30s and older) unaffected.<sup>228</sup> This ultrasonic

224 LRAD, "LRAD Corporation - PRODUCT OVERVIEW," accessed May 2, 2015, <http://www.lradx.com/site/content/view/15/110/>.

225 HyperSpike, "Civil and Defense," accessed March 3, 2023, <https://www.ultra-hyperspike.com/solutions/civil-and-defense/>.

226 Genasys, "LRAD The Global Leader in Acousting Hailing," accessed March 3, 2023, <https://genasys.com/>.

227 LRAD, "LRAD Corporation - PRODUCT OVERVIEW."

228 MST, "Mosquito Device Anti Loitering," *Moving Sound Technologies*, accessed May 2, 2015, <http://www.movingsoundtech.com/>.



device, sometimes branded “the Mosquito,” is used in several countries, primarily in private security settings, despite ongoing litigation against its use. It has been used as a deterrent device by the British police to disperse underage crowds with a shrill

sound and by civilians for personal use since 2008. As the marketing of these devices is unregulated, their use has the potential to expand rapidly.<sup>229</sup>

Sound origin	Sound level in decibels (dB)
Normal conversation	60 dB
Lawnmower	90 dB
Threshold of pain	110 – 130 dB, depending on tolerance
Sound cannon (continuous capability)	150 – 162 dB at 5 metres, 80 dB at 500 metres
Jet craft take-off	160 dB at 25 metres
Eardrum rupture	160 – 185 dB

Figure 12: Examples of sound levels.

Note: Adapted from “The National Institute for Occupational Safety and Health” (NIOSH): <http://www.cdc.gov/niosh/topics/noise/><sup>230</sup>

Since the 1990s, the U.S. military and private companies have also researched ultra- or infra-sonic devices that could theoretically cause tinnitus (ringing in the ears), pain, and cognitive and/or behaviour changes at either very high or very low frequencies that might not be heard by the human ear. While there are some reports of symptoms, sometimes called “Havana syndrome,” from such devices, there is no documented evidence that these weapons exist or have ever been used.

## Health effects

Sound cannons are used to emit painful, loud sounds that have the potential to cause significant harm to the eardrums and delicate organs of the ears and/or cause permanent hearing loss. The use of earplugs or firmly blocking the ears with hands can decrease the sound by 20–30 dB, but this may not be enough to avoid significant injury. Manufacturer guidelines indicate that sound cannons should only be used at a minimum distance of 10–20 metres.<sup>231</sup> There is a significant risk of injury to law enforcement officers, particularly those operating the

229 S Bungey, “London Anti-Riot Gear Gets High-Tech to Combat Youths,” *Daily Beast*, August 14, 2011, <https://www.thedailybeast.com/london-anti-riot-gear-gets-high-tech-to-combat-youths>.

230 “Noise and Hearing Loss Prevention,” *The National Institute for Occupational Safety and Health (NIOSH)*, December 5, 2014, <http://www.cdc.gov/niosh/topics/noise/>.

231 LRAD, “Memorandum: LRAD Corporation’s Position Statement on Product Classification” (LRAD Corporation, April 29, 2014), [https://www.uscommunities.org/fileadmin/hb/usc/Suppliers/Safeware\\_Mallory/LRAD\\_Position\\_Statement\\_121814.pdf](https://www.uscommunities.org/fileadmin/hb/usc/Suppliers/Safeware_Mallory/LRAD_Position_Statement_121814.pdf).

devices, who are advised to wear ear protection. In addition to auditory effects, acoustic weapons may also injure or rupture internal membranes of the middle and inner ear and, at close range, can damage other organs such as the lungs.

There is little medical literature regarding the effects of acoustic weapons on people. Some literature notes that acoustic weapons were first developed by the military and that any early evaluations of their health effects were biased and, in some cases, produced indeterminate findings. The weapons are indiscriminate, causing harm or pain to protesters, bystanders, and law enforcement, despite the narrow beam in which sound is concentrated. Abuse or lack of operator knowledge about the health effects can

easily lead to incorrect use of the weapon and exacerbate injuries. Serious questions remain about the safety and efficacy of acoustic weapons in crowd-control contexts.

## What has changed?

Since 2016, there has been a rapid expansion in the manufacture and sale of LRAD and other acoustic weapons. Sonic weapons have been widely deployed in countries such as Australia,<sup>232</sup> Hong Kong,<sup>233</sup> New Zealand,<sup>234</sup> and the United States,<sup>235</sup> prompting warnings from professional associations such as Audiology Australia<sup>236</sup> and the American Speech-Language-Hearing Association.<sup>237</sup>

---

232 RMIT ABC Fact Check, "'Sonic weapons' were used by police in Canberra's protests, but only to broadcast messages rather than do harm," Australian Broadcasting Corporation News, 17 February 2022, <https://www.abc.net.au/news/2022-02-18/coronacheck-sonic-weapons-lrad-police-canberra-protests/100839612/>.

233 Danny Mok, "Hong Kong protests: police use controversial anti-riot sound device for first time, rejecting claims it is harmful," *South China Morning Post*, 17 November 2019, <https://www.scmp.com/news/hong-kong/society/article/3038133/hong-kong-protests-police-use-controversial-anti-riot-sound>.

234 Oscar Francis, "Revealed: Police used sound cannons against Parliament protesters," *Otago Daily Times*, 28 June 2022, <https://www.nzherald.co.nz/nz/revealed-police-used-sound-cannons-against-parliament-protesters/PIBFZEHRIEADS7SK4Y4SWM464/>.

235 Genasys Inc., "Genasys™ Inc. LRAD® Systems Deployed by First Responders and Law Enforcement for Critical Crowd Communications," *GlobeNewswire*, 04 June 2020, <https://www.globenewswire.com/news-release/2020/06/04/2043685/0/en/Genasys-Inc-LRAD-Systems-Deployed-by-First-Responders-and-Law-Enforcement-for-Critical-Crowd-Communications.html>.

236 Audiology Australia, "Position Statement: Hearing Health and the Use of Long-Range Acoustic Devices," *Audiology Australia*, November 2020, <https://audiology.asn.au/Tenant/C0000013/AudA%20Position%20Statement%20-%20Hearing%20Health%20and%20the%20Use%20of%20Long-Range%20Acoustic%20Devices.pdf>.

237 The American Speech-Language-Hearing Association, "Long Range Acoustic Devices for Crowd Control Can Cause Serious Hearing Loss and Harm: Protestors Need Ear Protection and to be Aware of the Dangers (Full Statement)," *asha.org*, 11 June 2020, <https://www.asha.org/news/2020/long-range-acoustic-devices-for-crowd-control-can-cause-serious-hearing-loss-and-harm/>.

## Case study

## Court limits LRAD use by New York Police Department

### United States

After sustaining significant physical injuries as a result of the New York Police Department's (NYPD) use of a Long Range Acoustic Device (LRAD) sound cannon, protestors and journalists brought a lawsuit in March 2016 against the City of New York, challenging the NYPD's excessive use of force in violation of constitutional rights. The U.S. Court of Appeals for the 2<sup>nd</sup> Circuit ruled that purposely using LRAD in a manner capable of causing serious injury to non-violent protesters is a violation of the U.S. Constitution's Fourteenth Amendment prohibition against excessive force.<sup>238</sup> In June 2018, the court ruled that the device was an instrument of force designed for "incapacitating and painful effects" and that "the problem posed by protesters in the street did not justify the use of force, much less force capable of causing serious injury, such as hearing loss."<sup>239</sup>

Subsequently, the NYPD agreed to a legal settlement that included policy changes to the NYPD's use of LRADs.<sup>240</sup> Under the April 2021 settlement agreement, police officers are prohibited from using the painfully loud and high-pitched "deterrent" or "alert" tone, though they may make voice announcements

on the devices. The agreement also requires the department to change its training materials on the devices and states that while police supervisors and department lawyers may authorise the use of LRADs, officers "must make reasonable efforts to maintain minimum safe distances between the LRAD and all persons within its cone of sound."

The protestors who brought the lawsuit had attended racial justice demonstrations in New York City in December 2014 in their capacity as photojournalists, observers, filmmakers, or active protestors objecting to a grand jury decision not to indict the NYPD officer who killed Eric Garner. In the early morning hours of 5 December 2014, NYPD officers employed a type of LRAD called 100X to disperse nonviolent protesters. This acoustic weapon can "project messages up to 600 metres away, produce a maximum continuous output of 136 dB at one metre away, and has the capacity to overcome 88 dBs of background noise at 250 metres."<sup>241</sup> NYPD officers indiscriminately employed the device's deterrent tone between 15 and 20 times over a span of three minutes. At various points, NYPD officers angled and

238 *Edrei v Bratton*, No. 17-2065 (2d Cir. 2018); available at <https://law.justia.com/cases/federal/appellate-courts/ca2/17-2065/17-2065-2018-06-13.html>.

239 *Id.*

240 Colin Moynihan, "N.Y.P.D. to Limit Use of 'Sound Cannon' on Crowds After Protestors' Lawsuit," *The New York Times*, April 19, 2021, <https://www.nytimes.com/2021/04/19/nyregion/nypd-sound-cannon-protests.html>.

241 *Edrei v City of N.Y.*, 254 F. Supp. 3d 565 (S.D.N.Y. 2017).



A POLICE OFFICER HOLDS A LONG RANGE ACOUSTIC DEVICE (LRAD), OR SOUND CANNON, AS THEY BLOCK PROTESTORS ON A MARCH THROUGH TIMES SQUARE DURING A PROTEST AGAINST A GRAND JURY'S DECISION ON MONDAY NOT TO INDICT FERGUSON POLICE OFFICER DARREN WILSON IN THE SHOOTING OF MICHAEL BROWN, TUESDAY, NOV. 25, 2014, IN NEW YORK. THE GRAND JURY'S DECISION HAS INFLAMED RACIAL TENSIONS ACROSS THE U.S.  
AP PHOTO | JOHN MINCHILLO

fired the device fewer than 10 feet away from protestors.<sup>242</sup>

Due to their exposure to LRAD's ear-splitting sound, the plaintiffs suffered from physical injuries, such as "migraines, sinus pain, dizziness, facial pressure, ringing in ears, and sensitivity to noise."<sup>243</sup> One was diagnosed with tinnitus in both ears following the NYPD's use of the LRAD, while another was diagnosed with hearing loss due to nerve damage. Another plaintiff testified that he was told by his doctor that "the pressure of the extreme level of the noise from the LRAD had pushed a bone in his ear inwards, impacting and damaging a nerve in his ear."<sup>244</sup> Several of the plaintiffs named in the lawsuit say they

are now afraid to attend protests, which, for some, has negatively impacted their professional opportunities as journalists.<sup>245</sup>

In 2020, the company that manufactures LRADs, Genasys Inc., reported that law enforcement agencies and police departments in more than 100 countries,<sup>246</sup> including 500 U.S. cities used the devices.<sup>247</sup> With the policy changes resulting from the April 2021 settlement agreement, the NYPD became one of the first large U.S. police departments to ban the use of LRADs' shrill "deterrent" or "alert" tone.

---

242 *Id.*

243 *Id.*

244 See above n 234; Alex Pasternack, "Piercing sound can be excessive police force, federal court rules," Fast Company, June 14, 2018, <https://www.fastcompany.com/40585221/piercing-sound-can-be-excessive-police-force-federal-court-rules>.

245 *Id.*

246 LRAD, "LRAD Products," accessed March 9, 2023, "Case Study Law Enforcement," accessed March 3, 2023, [genasys.com/lrad-products/](https://www.genasys.com/lrad-products/)

247 Colin Moynihan, "N.Y.P.D. to Limit Use of 'Sound Cannon' on Crowds After Protestors' Lawsuit," The New York Times, April 19, 2021, <https://www.nytimes.com/2021/04/19/nyregion/nypd-sound-cannon-protests.html>.





# BLUNT FORCE WEAPONS (BATONS)

PORTLAND, OREGON - NOV 17: POLICE IN RIOT GEAR HOLDING THE LINE IN DOWNTOWN PORTLAND, OREGON DURING A OCCUPY PORTLAND PROTEST ON THE FIRST ANNIVERSARY OF OCCUPY WALL STREET NOVEMBER 17, 2011. JPL DESIGNS|SHUTTERSTOCK

## Weapon profile

The baton is perhaps the iconic police weapon, used as a symbol of authority, as a defensive tool, and as the most basic offensive armament available to police personnel throughout policing history. The classic baton is most broadly defined as a club-like, handheld, blunt, striking device, and many variations of the classic truncheon exist. There are other weapons that also cause blunt force trauma and are included in the analysis of these weapons in this section. These include the expandable baton, *tonfa* or side-handle baton, *sjambok* (rigid whips), and *lathi* (long sticks),<sup>248</sup> as well as innumerable objects with the potential to be used as clubs

or sticks. Blunt force weapons, in this broader sense, are generally constructed out of wood, rubber, PVC, or metal alloys and function through blunt trauma, with the level of injury dependent on a number of factors.

## Mechanism of action

Blunt force weapons are typically classified as defensive weapons, and a variety of blocking or parrying techniques can be used to accomplish this task. Blunt force weapons are also offensive impact weapons and function by transferring kinetic energy to a person to produce pain and temporary motor dysfunction.<sup>249</sup> They are typically used in this capacity to strike by swinging the weapon

248 Amnesty International, "Blunt Force: Investigating the misuse of police batons and related equipment," *Amnesty International*, September 2021, <https://www.amnesty.org/en/latest/research/2021/09/blunt-force/>.

249 Andrew Borrello, "Police Impact Weapons: A Foundation for Proper Selection," *Law and Order*, August 1999, v. 47, no. 8, p. 65-71, <https://www.ojp.gov/ncjrs/virtual-library/abstracts/police-impact-weapons-foundation-proper-selection>. See, also, Aled Roberts et al., "Impact characteristics of two types of police baton," *Forensic Science International*, June 1994, v. 67, no. 1, p. 49-53 [https://doi.org/10.1016/0379-0738\(94\)90411-1](https://doi.org/10.1016/0379-0738(94)90411-1).



with one or two hands against a targeted body part, often producing much more force than hands alone could.

Studies of typical duty-length batons in the United Kingdom and Canada (0.6-0.7 m) show comparable levels of peak impact forces between PVC, wood, and metal batons constructed for police use. By design, however, longer weapons impart greater impact by increasing the length of the lever.<sup>250</sup> A one-metre-long wooden stick weighing approximately 0.4kg can transfer in excess of 200 joules of energy to a target at speeds of over 30 metres per second.<sup>251</sup> Given the force multiplication involved, strikes are typically aimed away from the head, where strikes could be fatal; protocols dating to the 1960s advise against strikes to the head and other sensitive body parts.

In protests, batons are frequently employed with a two-handed grip, with both hands grasping opposite ends of the baton. The baton can be used to shove and strike with the butt ends. Batons wielded in this manner can also be used for joint locks or chokeholds and can be used to apply directed pressure to parts of the body as part of pain compliance techniques.

All blunt-force weapon strikes must be deliberately targeted by the user. Thus, the potential for “accidental” strikes is low.

However, peculiarities in the designs of police batons create scenarios in which they may be misused. Police directives regarding batons often mandate strikes be targeted at the extremities. To do this, side strikes (swinging the baton in a horizontal to a subhorizontal plane) are necessary. However, longer weapons can be difficult to deploy in this fashion, especially in crowds, resulting in their being used in an overhand strike where the baton is swung in a vertical plane. This use makes strikes to the head much more likely.

The tonfa, or side-handle baton, is a t-shaped baton featuring a small handle projecting away from the main body of the baton. Used properly, it is held either by the handle as a defensive tool, or by the main body with the handle close to the hand of the user. Used improperly, with the side-handle near the striking end of the baton, the weapon becomes a hammer. Reports from South Africa<sup>252</sup> and Italy<sup>253</sup> detail how the tonfa has been used in this manner to cause severe injuries.

Certain blunt-force weapon tactics can expose nonviolent individuals to the risk of police assaults. The police baton charge—a coordinated rush by baton-armed police to disperse crowds through pain and intimidation—creates a chaotic environment in which any individual may be a target for

---

250 Pierre Gervais et al., “Comparative analysis between police batons,” *Forensic Science International*, January 1998, v. 91, no. 1, p. 7-17, [https://doi.org/10.1016/S0379-0738\(97\)00177-1](https://doi.org/10.1016/S0379-0738(97)00177-1).

251 Florian Sprenger et al., “The influence of striking object characteristics on the impact energy,” *International Journal of Legal Medicine*, 2016, v. 130, p. 835-844 <https://link.springer.com/article/10.1007/s00414-015-1268-1>.

252 David Bruce, “The use of less-lethal weapons in South African prisons and crowd management,” *Institute for Security Studies Monographs*, November 2019, monograph 201 <https://hdl.handle.net/10520/EJC-1d321dbe67>.

253 Nick Davies, “The bloody battle of Genoa,” *The Guardian*, 16 July 2008, <https://www.theguardian.com/world/2008/jul/17/italy.g8>.

police baton strikes. The ensuing panic is indiscriminate in nature and exposes civilians to the additional risks of falls and trampling. In India, the “lathi charge” is a common police tactic used to disperse crowds; deaths related to lathi charges frequently occur, including those of young children and individuals not involved in protests or gatherings.

## Health effects

Blunt force trauma of any kind can produce injuries ranging from bruises to life-threatening injuries. Contusions (bruising) are most common and caused by ruptured capillaries under the skin surface. Abrasions or lacerations from the force of the weapon can result in external bleeding. The force of the strike can cause internal injuries as well, including bone fractures, internal bleeding, and organ damage. Strikes of sufficient force can break bones, rupture organs, and potentially kill. Blunt force weapons used for chokeholds or joint locks can cause strangulation injuries and joint or neck trauma.

Strikes to the head are most likely to cause life-threatening injuries. Retrospective studies of homicide victims have shown that the vast majority (>80%) of victims of blunt force trauma suffered injuries to the head.<sup>254</sup> Blunt force trauma to the head and neck can cause death through traumatic brain injury, internal haemorrhage, or paralysis. Sharp impacts to the face can rupture eyes and eardrums as well as delicate facial bones,

with potentially permanent consequences. Strikes to the neck or back can injure the vital central nervous system. Strikes to the torso can cause serious internal injuries. In the chest, rib fractures and lung injuries such as punctured, bleeding, or bruised lungs can result in life-threatening respiratory complications. Injuries to the heart can result in cardiac tamponade that requires emergent management for survival. In the abdomen, organ rupture (especially of solid organs such as the liver, lungs, spleen, or kidneys) can result in severe pain and severe internal bleeding. Hollow organs such as the intestines can rupture well, but these are less likely. Pregnant women with blunt trauma to the abdomen can miscarry. Strikes to the limbs can fracture bones or injure nerves and vessels, which may result in further bleeding or injury. Strikes anywhere on the body can cause permanent impairment through musculoskeletal or nerve injury. In the long term, infections from wounds, psychological trauma, and disfigurement can occur. While most injuries are temporary, depending on the site and degree of injury, permanent disability is not uncommon. .

A comprehensive investigation of police baton uses by Amnesty International highlights the numerous health risks of baton strikes, including the risk of permanent disability or death, even when used against non-vital areas such as the limbs.<sup>255</sup> Decades of case reports in the medical literature describe batons’ characteristic parallel linear contusions and abraded contusions, as well

---

254 Vipul Namdeorao Ambade and Hemant Vasant Godbole, “Comparison of wound patterns in homicide by sharp and blunt force,” *Forensic Science International*, January 2006, v. 156, no. 2-3, p. 166-170 <https://doi.org/10.1016/j.forsciint.2004.12.027>.

255 Amnesty International, “Blunt Force: Investigating the misuse of police batons and related equipment,” *Amnesty International*, September 2021, <https://www.amnesty.org/en/latest/research/2021/09/blunt-force/>.

as the associated internal injuries and long-term disabilities. Descriptions of the scarring patterns and potential injuries produced by baton strikes are detailed in the Istanbul Protocol as well.<sup>256</sup>

Case law on baton use in protests is limited. The attack on the Diaz-Pertini school in Genoa during the 27th G8 Summit in 2001 was one important example. Over 150 police, armed principally with rubber side-handle batons, indiscriminately attacked the 93 occupants of the school. Court proceedings illustrate the nature of injuries suffered by the protesters specifically attributable to batons, including traumatic brain injury; epidural hematoma; pneumothorax; fractures to the skull, jaw, and ribs; fractured teeth; lacerations; contusions; hearing loss; and permanent muscle weakness.<sup>257</sup> Several protesters took their cases to the European Court of Human Rights (ECtHR), claiming violations of Article 3 of the European Convention on Human Rights (Prohibition of torture). In *Cestaro v Italy*, the ECtHR ruled

that the actions of police with regard to one of the protesters severely beaten with batons at the Diaz-Pertini school constituted torture under Article 3.<sup>258</sup> The ECtHR sustained their opinion in a separate ruling, *Bartesaghi Gallo and Others v Italy*, declaring that the misuse of police batons on individuals in the Diaz-Pertini school similarly constituted torture.<sup>259</sup>

Perhaps uniquely among the less-lethal weapons described in this report, police blunt force weapons have been frequently used as instruments of sexual assault in the context of protests. Protesters in Belarus,<sup>260</sup> Chile,<sup>261</sup> France,<sup>262</sup> and the United States<sup>263</sup> have recently alleged sexual assault at the hands of police using batons, with some of these assaults captured on video.

---

256 See, also, Office of the United Nations High Commissioner for Human Rights, "ISTANBUL PROTOCOL," *United Nations*, 2022, no. 8, rev. 2, [https://www.ohchr.org/sites/default/files/documents/publications/2022-06-29/Istanbul-Protocol\\_Rev2\\_EN.pdf](https://www.ohchr.org/sites/default/files/documents/publications/2022-06-29/Istanbul-Protocol_Rev2_EN.pdf).

257 *AFFAIRE BARTESAGHI GALLO ET AUTRES c. ITALIE*, European Court of Human Rights, Requêtes nos 12131/13 et 43390/13 <https://hudoc.echr.coe.int/eng#%7B%22itemid%22:%5B%22001-174443%22%5D%7D>. See, also, *CASE OF CESTARO v ITALY*, European Court of Human Rights, Application no. 6884/11 <https://hudoc.echr.coe.int/eng#%7B%22itemid%22:%5B%22001-153901%22%5D%7D>.

258 *Id.*

259 See above n 254.

260 Human Rights Watch, "Belarus: Systematic Beatings, Torture of Protesters," Human Rights Watch, 15 September 2020, <https://www.hrw.org/news/2020/09/15/belarus-systematic-beatings-torture-protesters>.

261 CNN, "La grave denuncia por tortura y abuso sexual de un joven en medio de la crisis en Chile," 1 November 2019, <https://www.cnn.com/videos/spanish/2019/11/01/denuncia-abuso-sexual-policia-carabineros-chile-protestas-crisis-protestas-pkg-cristopher-ulloa.cnn>.

262 Liselotte Mas, "French police investigate officer caught on video wedging baton in protester's pants," *France24*, 6 May 2019, <https://observers.france24.com/en/20190506-france-police-investigate-baton-protester>.

263 David Sachs, "Everything we know – and don't – about the claim that a Denver police officer violated a protester with a baton," *Denverite*, 21 September 2020, <https://denverite.com/2020/09/21/everything-we-know-and-dont-about-the-claim-that-a-denver-police-officer-assaulted-a-protester-with-a-baton/>.

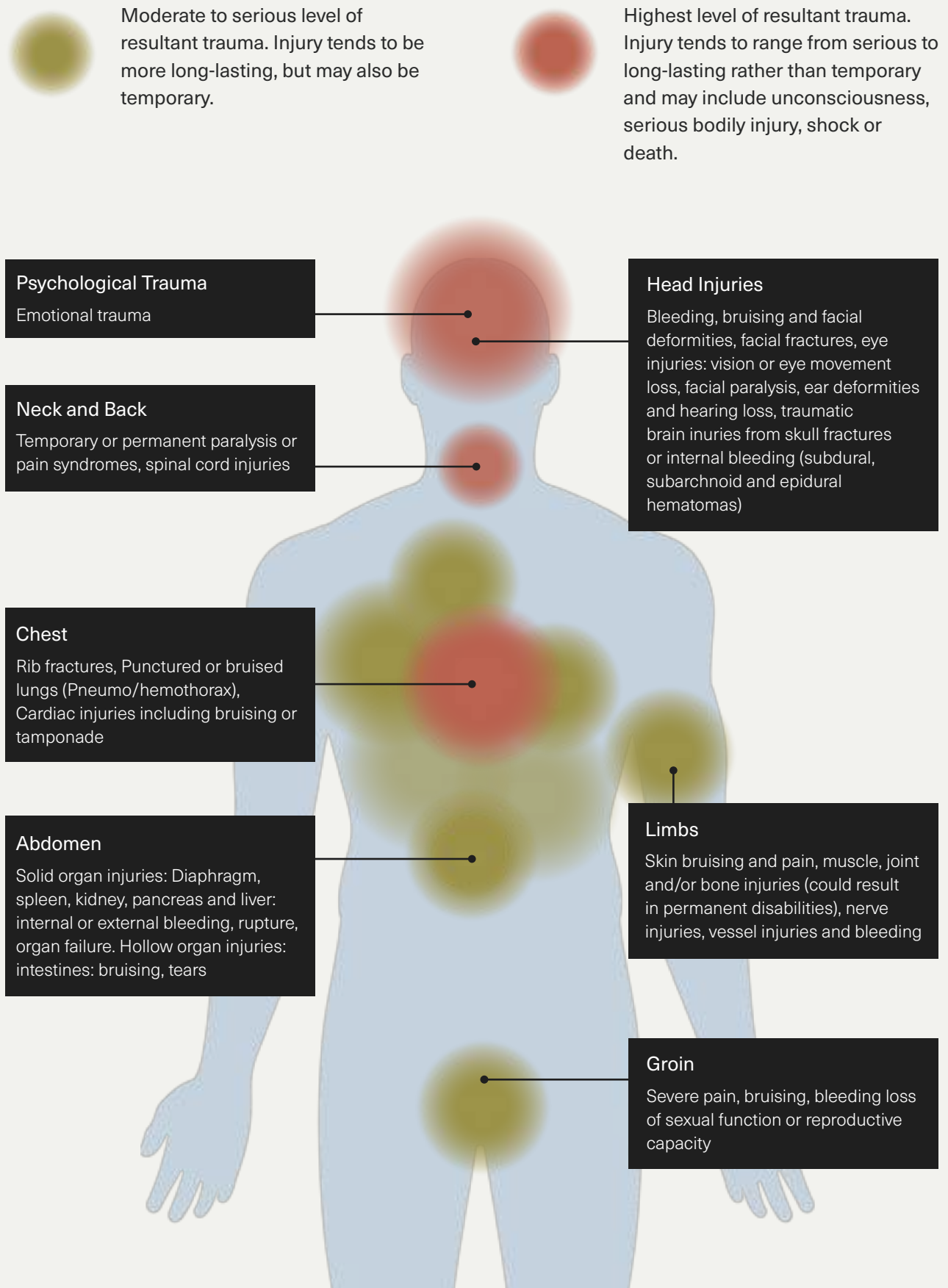

Image 2: adapted from Amnesty International: <https://www.amnesty.org/en/latest/research/2021/09/blunt-force/>

## Case study

## Lathi charge, a deadly holdover from colonial times

### India

The *lathi* is a type of baton used across South Asia, consisting of a 1-1.8 m rod usually made of bamboo. While traditionally associated with South Asian martial arts, the adoption of the lathi as a policing tool followed the United Kingdom's promotion of its use for crowd control in British India during the 19th century.<sup>264</sup> Today, the lathi continues to be omnipresent in the hands of modern Indian police, and its use in crowd control has been implicated in dozens of deaths over the past decade.

Police use of the lathi is inextricably tied to a tactic known in India as the lathi charge. In essence, a baton charge consists of a coordinated rapid advance by police, using lathis to strike at individuals and disperse a crowd through the threat of pain. Like baton charges around the world, the chaotic environment created by a sudden rush of armed police leads to direct injuries from lathi strikes and indirect injuries from the panicked crowd. Unlike other nations' baton charges, however, the Indian police's extensive use of the tactic is linked with a startling number of deaths.

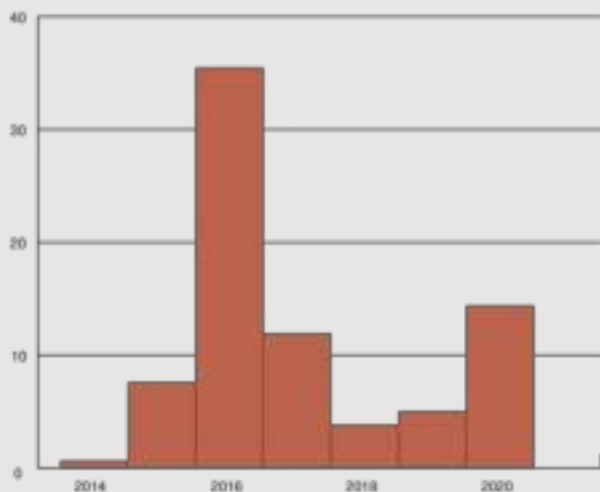

Civilian deaths during lathi charges, national

The medical literature of the earliest 20th century recognized the danger posed by lathis. One report from 1902 specifically noted 14 deaths from skull fractures and three deaths from a cerebral haemorrhage at a single medical centre in Bihar.<sup>265</sup> Perhaps the best-known victim of a lathi charge lived during this period of violence. Lala Lajpat Rai, a leader of the Indian independence movement, was fatally wounded in 1928 during a lathi charge ordered by the British superintendent of police in Lahore (modern Pakistan).<sup>266</sup>

264 Delhi News, "Symbol of power and control, a lathi story," *Hindustan Times*, 22 December, 2019, <https://www.hindustantimes.com/delhi-news/symbol-of-power-and-control-a-lathi-story/story-FHVzYKALGQYX4g8kwpgBRN.html>.

265 R.K. Gupta, "Injuries Caused by *Lathi* Blows," *Indian Medical Gazette*, 1902, vol. 37, no. 6, pp. 243-244, <https://www.ncbi.nlm.nih.gov/pmc/articles/PMC5156271/>.

266 Hindustan Times, "Lala Lajpat Rai Birth Anniversary: The legacy of the famed nationalist," *Hindustan Times*, 27 January 2020, <https://www.hindustantimes.com/more-lifestyle/lala-lajpat-rai-birth-anniversary-the-legacy-of-the-famed-nationalist/story-ituwNX2DVDKdWm4Qas2Z8J.html>.



INDIAN SECURITY FORCES INTERVENE IN FARMERS DURING A RALLY AS THEY CONTINUE THEIR PROTEST AGAINST THE CENTRAL GOVERNMENT'S RECENT AGRICULTURAL REFORMS IN NOIDA, INDIA ON JANUARY 26, 2021. PANKAJ NANGIA | AA



Over a hundred years later, little has changed about the prevalence of the lathi in policing. Victims span demographic divides, although lathi charges have been especially pervasive in police response to student protests, enforcement of COVID-19 restrictions,<sup>267</sup> and response to demonstrations by rural workers.<sup>268</sup> The chaotic nature of lathi charges results in serious injuries to bystanders, such as one case in which a 18-month-old died from head injuries in 2021<sup>269</sup> and another in which an eight-year-old boy died in a stampede produced by lathi charges in 2019.<sup>270</sup>

Since 2015, the Indian National Crime Records Database has recorded in its annual *Crime in India* reports the civilian injuries and fatalities resulting from police lathi charges.<sup>271</sup> These reports found 78 civilians have died in police lathi charges since 2014. Over 2,000 civilian injuries from police lathi charges were recorded during this time period.

No details are available pertaining to the injuries that led to the fatalities, and it is likely that at least some of the deaths may be attributed to crowd crushing or trampling in the panicked environment that often follows a lathi charge. Strikes to the head likely account for many of the fatalities from lathis. The significant length of the lathi may account for the high number of fatalities. Impact energy at the tip of a baton increases in proportion to the length of the lever (baton and arm),<sup>272</sup> so the exaggerated length of the typical lathi can cause severe injuries. Furthermore, in crowds, the length of the lathi limits the use of slashing strikes from the sides, leaving the dangerous overhand strike as the most viable option.

267 See <https://thewire.in/law/police-lathi-coronavirus-lockdown>.

268 See <https://www.aninews.in/news/national/general-news/reaching-karnal-to-see-justice-for-farmer-killed-in-lathi-charge-by-haryana-police-alleges-rakesh-tikait20210907160123/> and <https://www.hindustantimes.com/india-news/56-year-old-migrant-worker-on-his-way-to-home-dies-on-road-28-year-old-migrant-dies-in-police-lathicharge-in-surat/story-O1N11kDAWYRAAQOg4dkT6M.html>.

269 See <https://www.freepressjournal.in/bhopal/watch-video-6-month-old-girl-died-in-police-lathi-charge-in-shivpuri-one-police-officer-sustains-head-injuries> and <https://www.thequint.com/news/india/15-year-old-dies-allegedly-during-lathi-charge-by-cops-on-villagers-in-mps-shivpuri>.

270 See <https://www.telegraphindia.com/india/lathi-fuelled-stampede-kills-child-in-varanasi/cid/1729257>.

271 See <https://ncrb.gov.in/en/crime-india>.

272 Komaal Collie, "A Pilot Study of Kinetic Energy Transfer Based Upon Police Baton Designs," *Law Enforcement Executive Forum*, 2009, v. 9, no. 1, pp. 119-126, [https://www.researchgate.net/publication/263808533\\_A\\_Pilot\\_Study\\_of\\_Kinetic\\_Energy\\_Transfer\\_Based\\_Upon\\_Police\\_Baton\\_Designs](https://www.researchgate.net/publication/263808533_A_Pilot_Study_of_Kinetic_Energy_Transfer_Based_Upon_Police_Baton_Designs).

## Case study

## Baby Pendo's death from batons during a police operation

### Kenya

"Jose, Jose, they have killed our child," cried the mother of six-month-old Samantha Pendo after Kenyan police officers used tear gas and batons to attack the mother, her husband, and their infant child. The brutal use of baton strikes by the police left baby Pendo with severe head injuries, from which she later died.

On 8 August 2017, Kenyans went to the polls in a presidential election. Following the announcement of results by the Independent Electoral and Boundaries Commission (IEBC), the incumbent Uhuru Kenyatta was declared the winner after garnering 54.3 per cent of the votes; his main rival, opposition leader Raila Odinga, garnered 44.74 per cent of the votes. Odinga rejected the results and claimed the election process was marred by fraud and numerous irregularities.<sup>273</sup> Violent protests soon erupted in opposition strongholds, including Nairobi, the Coast and Western Kenya. Using live ammunition, batons, teargas, and other CCWs, the police carried out violent house-to-house operations, beating and shooting protesters who objected to the outcome of the election.

On 11 August 2017, Joseph Abanja, his wife Lenser Achieng Abanja, and their baby

daughter Pendo were woken up at about 12.30 am by the screams of a neighbour who was being attacked by police. Their house in Nyalenda Estate, an informal settlement outside Kisumu, was soon surrounded by police officers. The police lobbed a tear gas canister through a crack in the door, forcing the family out of their house and toward the waiting police.

Achieng cradled Baby Pendo in her left arm, pleading with the police not to beat her with their batons, especially because of her infant. But two officers descended on her, beating her on her left side and striking Baby Pendo on the head.

Baby Pendo was rushed by her parents to Aga Khan hospital in Kisumu where she spent four days in the intensive care unit and then died.<sup>274</sup> A post-mortem report found that she had suffered a fractured skull. A public inquest ordered by the Magistrate Court in Kisumu found that Baby Pendo had indeed died from injuries sustained from officers who had broken into her parents' house while pursuing residents protesting the outcome of the presidential election.

<sup>273</sup> See <https://www.nytimes.com/2017/08/09/world/africa/kenya-election-results-raila-odinga.html>.

<sup>274</sup> See <https://www.standardmedia.co.ke/nyanza/article/2001251483/kisumu-s-baby-pendo-who-was-hit-by-police-officers-loses-fight-for-life-after-five-days-in-coma>.



IN KISUMU, KENYA, WHERE PRESIDENTIAL, GENERAL AND LOCAL ELECTIONS WERE BEING HELD, OPPOSITION SUPPORTERS WERE MET BY POLICE AS THEY CONTESTED THE RESULTS ON AUGUST 9, 2017. PHOTO BY STINGER | AA

On 14 February 2019, a Magistrate's Court found five police officers culpable for the death of Baby Samantha Pendo.<sup>275</sup> In addition, the court established that under the doctrine of command responsibility, the respective commanders failed to take reasonable measures to prevent the officers' criminal action. In her ruling, Magistrate Beryl Omollo placed particular responsibility on senior officers involved in the policing of the protests, stating that, "based on the command responsibility in the National Police Service, the commanders in charge of the operations were found liable for the death of the deceased baby Samantha Pendo." The magistrate also recommended charges against 30 General Service Unit officers from the Kenya Police Service who were involved in the operation.<sup>276</sup> At the end of 2022, Director of Public Prosecutions Noordin Haji called for

the arrest and prosecution of involved police officers for crimes against humanity under "superior/command responsibility" principle of international law. This could finally lead to some form of accountability as the officers (at the time of this report's publication) had not been penalised in any way despite the court's findings.

According to the Kenya National Commission on Human Rights, there were 57 fatalities, including of minors, during the 2017 election-related protests in Kenya. None of those cases has been conclusively investigated. There is an urgent need for the Kenyan Government to comprehensively investigate the multiple incidents in which police used lethal CCWs against peaceful demonstrators and bystanders.

275 See <https://www.youtube.com/watch?v=oR3RiW4BAFo&t=4s>.

276 Harold Odhiambo, "Baby Pendo: Police officers to be charged," *The Standard*, December, 2022. <https://www.standardmedia.co.ke/article/2001459310/at-last-justice-on-the-way-for-baby-pendo>





“A US MARINE CORPS TRUCK IS SEEN CARRYING A PALLETIZED VERSION OF THE ACTIVE DENIAL SYSTEM, MARCH 9TH, 2012, AT THE US MARINE CORPS BASE QUANTICO, VIRGINIA.” PAUL J. RICHARDS | AFP/GETTY IMAGES

## Overview

The market for CCWs continues to expand and evolve. Every year, manufacturers make more CCWs and develop new ones, increasing the likelihood of people being injured or killed by them. It is not possible to adequately assess the risk of CCWs developed in secret until either manufacturers become more transparent in their testing processes or civilians become unwitting guinea pigs in the streets. In this report, we have attempted to note the technological developments shaping existing CCWs in the respective sections describing each weapon type. But in this section, we highlight novel, emerging technologies being used for crowd control and attempt to describe the potential risks of these newer weapons. Some of these weapons have been available for decades

for policing or military purposes but are now increasingly being used for crowd control. Other weapons are still in development.

## Electronic control devices

### Weapon profile

An electronic control device (ECD), also known as a conducted energy device or electric shock weapon, refers to any of several weapons that use painful electric currents to immobilise or deter aggressors.

Primitive ECDs - cattle prods - gained notoriety after their use in suppressing protests during the Civil Rights movement in the United States during the 1960s.<sup>277</sup> In the recent past, ECDs are occasionally used for crowd control either during protests<sup>278</sup> or during

277 Lisa Rogers, “Brutal tactics used against area protestors,” *The Gadsden Times*, April 24, 2003 <https://www.gadsdentimes.com/story/news/2003/04/25/brutal-tactics-used-against-area-protestors/32343966007/>.

278 Current Time, “Russian Police Try To End Navalny Rallies With Shock Batons, Beatings, Wide-Sc” <https://en.currenttime.tv/a/russian-police-try-to-end-navalny-rallies-with-tasers-beatings-and-massive-detentions/31079064.html>. See, also, <https://dailynewshungary.com>.

sporting events,<sup>279</sup> but elsewhere their use is uncommon outside of carceral settings. ECDs are extensively used in prisons worldwide,<sup>280</sup> both as instruments of individual control and to suppress mass dissent within the carceral system. Their increasing appearance on the streets represents a disconcerting shift in policing philosophy, wherein a technology of prisoner control is leveraged against civilians exercising their basic rights.

There are three main kinds of electric shock weapons (direct contact weapons, projectile electric shock weapons, and body-worn electric shock devices), although only direct contact and projectile electric shock weapons are discussed in this report.

## Mechanism of action

ECDs function by passing a high-voltage, low-amperage current between two electrodes. These electrodes may be placed in handheld devices (known as “shock prods,” “stun guns,” or “shock shields”) that must be pressed against an individual to take effect, or they may use compressed air to fire

hooked barbs that serve as electrodes and can shock an individual from a distance (the TASER XREP).<sup>281</sup> They may also be capable of both modes of operation (TASER X26)<sup>282</sup> or be part of body-worn electric conduction devices (such as stun belts or cuffs).<sup>283</sup> Newer, wireless, long-range ECDs consist of projectiles containing electrodes that are shot from firearms and use a remote power source.<sup>284</sup>

If the electrodes are in contact with the human body, the body completes the circuit and the current is passed through the individual, resulting in pain and possibly electrical injury. They are advertised as non-lethal because they generate pulses of very high open-circuit voltages (at times in excess of 50,000 volts) and very low average amperages (several milliamperes or less). However, in practice, closed-circuit voltages and actually measured amperages can differ significantly from the values advertised by manufacturers.<sup>285</sup> Furthermore, some professional-grade ECDs can generate over ten times the electrical charge per pulse (typically measured in micro coulombs)

---

[com/police-shocked-a-demonstrator-in-budapest/](https://www.bleacherreport.com/police-shocked-a-demonstrator-in-budapest/).

279 Marc Roseblade, “Zenit St Petersburg Player Tasered by Police After Handing Shirt to Young Fan,” *Bleacher Report*, June 21, 2011, <https://bleacherreport.com/articles/743283-zenit-st-petersburg-player-tasered-by-police-after-handing-shirt-to-young-fan>.

280 Omega Research Foundation, “Compliance through Pain: Electric shock equipment in South African prisons,” *Institute for Security Studies*, Policy Brief 86, (June 2016): <https://omegaresearchfoundation.org/sites/default/files/uploads/Publications/Compliance%20through%20pain.pdf>

281 Circuits Today, “XREP - A Combination of Taser and Shotgun,” Circuits Today, July 6, 2011, <https://www.circuitstoday.com/xrep-%E2%80%93-a-combination-of-taser-and-shotgun>.

282 A note that at the time of the report, Taser discontinued TASER XREP and TASER X26. Giron, Lisa, “More power, more risk and a quiet exit for Taser’s best-selling product,” Reuters, September 27, 2017, <https://www.reuters.com/investigates/special-report/usa-taser-x26/#:~:text=After%20signs%20of%20the%20outsized,end%2C%20Taser%20abandoned%20the%20effort>.

283 Omega Research Foundation, “Visual Guide to Law Enforcement and Security Equipment,” *Omega Research Foundation*, 2021, [https://omegaresearchfoundation.org/sites/default/files/uploads/uploads/Visual%20Guide%20Final\\_ENG\\_0.pdf](https://omegaresearchfoundation.org/sites/default/files/uploads/uploads/Visual%20Guide%20Final_ENG_0.pdf).

284 See <https://www.police.hu/hu/hirek-es-informaciok/legfrissebb-hireink/zsaru-magazin/rendszerben-a-sokkolo> for guidance on Hungarian police training.

285 U.S. Department of Justice, “Study of Deaths Following Electro Muscular Disruption,” *NIJ Special Report* NCJ 233432, May 2011, <https://www.ojp.gov/pdffiles1/nij/233432.pdf>.



than their commercial counterparts.<sup>286</sup> This electrical charge generated is sufficient to cause severe pain and involuntary muscle contractions.

## Health effects

Electronic control devices are considered by law enforcement to cause significant pain but carry a limited risk of death, but this claim is controversial.<sup>287</sup> Although the risk of death from electrocution from better-tested models of ECDs has been shown to be low,<sup>288</sup> the use of ECDs are associated with potentially fatal injuries,<sup>289</sup> and ECDs have been identified as contributing factors in over 100 in-custody deaths in the United States.<sup>290</sup> Repeated shocks can result in more significant injuries, as can extended shock durations. Electrical

conduction devices that carry more powerful electrical charges can also produce more significant injuries. Cardiac arrhythmias, muscle damage, and electric burns (both on the skin and internally) may result from the electrical conduction itself. There are numerous case reports of injuries from ECDs, but few systematic reviews examining the scope and scale of these injuries. Fatal and debilitating injuries can also occur as a result of falls secondary to loss of neuro-muscular control while the current is active<sup>292</sup> or burns caused by arc ignition of flammable vapours.<sup>293</sup> Barb-style electrodes are designed to penetrate skin and can result in serious traumatic injuries, such as skull penetration<sup>294</sup> and enucleation of the eye.<sup>295</sup> Wireless long-range ECDs are in effect KIPs, with experimental studies showing that

286 Lisa Girion, "The X26," *Reuters Investigates*, September 21, 2017, <https://www.reuters.com/investigates/special-report/usa-taser-x26/>.

287 Amnesty International, "USA: 'Less than lethal'? The use of stun weapons in US law enforcement," *Amnesty International*, December 16, 2008, <https://www.amnesty.org/en/documents/AMR51/010/2008/en/>.

288 Sebastian N. Kunz et al., "Functioning and Effectiveness of Electronic Control Devices Such as the TASER M- and X-Series: A Review of the Current Literature," *Journal of Forensic Sciences* 57, no. 6 (2012), 1591-1594 <https://onlinelibrary.wiley.com/doi/10.1111/j.1556-4029.2012.02167.x>.

289 Mathieu Pasquier et al., "Electronic Control Device Exposure: A Review of Morbidity and Mortality," *Annals of Emergency Medicine* 58, no. 2 (2011): 178-188 <https://linkinghub.elsevier.com/retrieve/pii/S0196064411001004>.

290 Reuters Staff, "Reuters finds 1,005 deaths in U.S. involving Tasers, largest accounting to date," *Reuters*, August 22, 2017, <https://www.reuters.com/article/us-axon-taser-toll-idUSKCN1B21AH>.

291 Jo Ciavaglia et al., "Lethal force? Tasers are meant to save lives, yet hundreds die after their use by police," *USA Today*, April 23, 2021, <https://www.usatoday.com/in-depth/news/investigations/2021/04/23/police-use-tasers-ends-hundreds-deaths-like-daunte-wright/7221153002/>.

292 Kroll et al., "Fatal traumatic brain injury with electrical weapon falls," *Journal of Forensic and Legal Medicine* 43 (2016): 12-19 <https://linkinghub.elsevier.com/retrieve/pii/S1752928X16300695>.

293 Kroll et al., "Fatal and non-fatal burn injuries with electrical weapons and explosive fumes," *Journal of Forensic and Legal Medicine* 50 (2017): 6-11 <https://www.sciencedirect.com/science/article/abs/pii/S1752928X17300768>.

294 Isabelle Le Blanc-Louvry et al., "A brain penetration after Taser injury: Controversies regarding Taser gun safety," *Forensic Science International* 221, no. 1-3 (2012): e7-e11, <https://www.sciencedirect.com/science/article/abs/pii/S0379073812001521>.

295 Leon Rafailov et al., "Impaled Orbital TASER Probe Injury Requiring Primary Enucleation," *Ophthalmic Plastic and Reconstructive Surgery* 33, no. 3S (2017): S176-177, <https://www.sciencedirect.com/science/article/abs/pii/S0379073812001521>.

malfunctioning wireless ECDs can penetrate the human body.<sup>296</sup>

So-called “shock shields” or “e-shields”—polycarbonate shields embedded with metal conductors designed to deliver electric shocks—have been carried by riot police in India<sup>297</sup> and in the United States.<sup>298</sup> Shock shields are commonly used by prison guards in the United States<sup>299</sup> and South Africa.<sup>300</sup> They have been implicated in at least one death—a corrections officer who suffered cardiac arrest after being subjected to compulsory training shocks from an e-shield.<sup>301</sup> The amount of electrical charge permitted in these weapons is not public information and therefore challenging to measure.

As ECDs proliferate throughout the world, their risk is amplified. The lack of manufacturing transparency and regulation limits the ability of health workers and advocates to understand the quality and range of these weapons. A large number of the experimental and retrospective scientific studies found in this review were funded by and describe

TASER-branded products (produced by Axon Enterprise, Inc). The conclusions drawn by these studies cannot be applied to weapons produced by other manufacturers, which may use different electrical parameters, pulse durations, and delivery systems.<sup>302</sup> Of note, as ECDs were marketed and their use increased in the 1990s, research on and use of kinetic impact projectiles is thought to have concurrently dropped. But as more research on the dangers of ECDs has emerged, the manufacture, research into, and use of kinetic impact projectiles have once again risen.

## Directed energy weapons

### Active Denial System (ADS)

The previous version of this report described the Active Denial System (ADS), a “heat ray” developed by the United States Department of Defense. This vehicle-mounted device would direct millimetre-wave energy towards a crowd, heating the epidermis and generating radiation burns on the surface of the body of those it hit. To date no operational uses of this weapon have been recorded, in

---

296 Scott R. Lucas, et al., “Assessment of the TASER XREP Blunt Impact and Penetration Injury Potential Using Cadaveric Testing,” *Journal of Forensic Sciences* 58, no. s1 (2013): S60-S68, <https://onlinelibrary.wiley.com/doi/abs/10.1111/j.1556-4029.2012.02298.x>.

297 Express News Service, “Delhi: Shield that emits shock new part of force’s anti-riot gear,” *The Indian Express*, December 28, 2019, <https://indianexpress.com/article/cities/delhi/shield-that-emits-shock-new-part-of-rapid-action-forces-anti-riot-gear-6188184/>.

298 WREG Web, “Here’s the story behind those electrified ‘e-shields’ authorities were carrying during Memphis protests,” *Fox40 News*, September 26, 2020, <https://fox40.com/news/national-and-world-news/heres-the-story-behind-those-electrified-e-shields-authorities-were-carrying-during-memphis-protests/>.

299 Association of the Bar of the City of New York Committee on Corrections, “Report of Subcommittee on Conditions of Confinement on the Use of Stun Shields by the New York City Department of Correction,” *New York City Bar Association*, 2001, <https://www.nycbar.org/pdf/report/stun%20shield%20report.pdf>.

300 David Bruce, “The use of less-lethal weapons in South African prisons and crowd management,” *Institute for Security Studies Monograph 201*, November 2019, [https://media.africaportal.org/documents/The\\_use\\_of\\_less\\_lethal\\_weapons\\_in\\_SA\\_prisons.pdf](https://media.africaportal.org/documents/The_use_of_less_lethal_weapons_in_SA_prisons.pdf).

301 Anne-Marie Cusac, “Stunning Technology,” *The Progressive Magazine*, July 1, 1996 <https://progressive.org/magazine/stunning-technology-cusac/>.

302 Christos Baliatsas et al., “Human Health Risks of Conducted Electrical Weapon Exposure: A Systematic Review,” *JAMA Network Open*, 2021, vol. 4, no. 2, e2037209, doi:10.1001/jamanetworkopen.2020.37209.

spite of requests by US military police to use it against protesters,<sup>303</sup> and requests by US Customs and Border Patrol to use it against migrants.<sup>304</sup> There are several reasons for the reluctance to deploy the Active Denial System. These include safety concerns, ethical and human rights considerations, as well as practical concerns—such as the weapon's weight and long warm-up time.<sup>305</sup>

### Other directed energy weapons

The laser “dazzler,” also known as the “blinding laser” or “blinding dazzler,” uses intense, directed radiation to temporarily disorient individuals with (purportedly temporary) blindness from very bright laser lights. Dazzlers have been quietly deployed by the United States military in Iraq as a less-lethal option to “deter non-combatants” in conflict settings.<sup>306</sup> These devices—largely class 3B green lasers—were used as signalling or deterrent devices at checkpoints,<sup>307</sup> similar to acoustic weapons such as the LRAD. They are designed to be flashed at vehicles or individuals to draw attention, warn off, or disorient/distract. Although no data are

available on injuries to Iraqi civilians, the introduction of high-powered laser dazzlers was associated with a spike in accidental exposures to soldiers, including 45 injuries and one case of permanent blinding.<sup>308</sup>

Newer devices under development blur the lines between directed energy weapons, distraction devices, and acoustic weapons. The US Department of Defense continues to invest in research and development of “laser-induced plasma effect” (LIPE) weapons. LIPE weapons use high-energy pulsed laser beams to produce and manipulate a cloud of plasma. Prototypes allow for effects including superheating a surface, creating a series of loud explosions, or transmitting spoken instructions over long distances.<sup>309</sup>

### Remotely-operated vehicles (drones)

#### Weapon profile

Remotely-operated vehicles (ROVs) have been increasingly used over the six years since our previous report, both to provide

---

303 Dina Temple-Raston, “Military Confirms It Sought Information on Using ‘Heat Ray’ Against D.C. Protesters,” *NPR*, September 16, 2020 <https://www.npr.org/2020/09/16/913748800/military-police-leaders-weighed-deploying-heat-ray-against-d-c-protesters>.

304 Sebastien Roblin, “Border Patrol Officials Proposed Using Pain-Inducing Heat Ray On Migrants. Here’s Why The U.S. Hasn’t Used It – Yet,” *Forbes*, August 27, 2020 <https://www.forbes.com/sites/sebastienroblin/2020/08/27/customs-and-border-patrol-proposed-using-pain-inducing-active-denial-heat-ray-on-border-migrants/?sh=2ffbdf1b7457>.

305 Tim Elfrink, “Safety and ethics worries sidelined a ‘heat ray’ for years. The feds asked about using it on protesters,” *The Washington Post*, September 17, 2020 <https://www.washingtonpost.com/nation/2020/09/17/heat-ray-protesters-trump-dc/>.

306 Jeff Hecht, “PHOTONIC FRONTIERS: NONLETHAL LASERS: Nonlethal lasers deter attacks and warn away noncombatants,” *Laser Focus World*, 01 April 2013, <https://www.laserfocusworld.com/lasers-sources/article/16556977/photonic-frontiers-nonlethal-lasers-nonlethal-lasers-deter-attacks-and-warn-away-noncombatants>.

307 Joint Non-Lethal Weapons Program, “Non-Lethal Optical Distracters Fact Sheet,” May 2016, [https://jnlwp.defense.gov/Portals/50/Documents/Press\\_Room/Fact\\_Sheets/NL\\_Optical\\_Distracters\\_Fact\\_Sheet\\_May\\_2016.pdf](https://jnlwp.defense.gov/Portals/50/Documents/Press_Room/Fact_Sheets/NL_Optical_Distracters_Fact_Sheet_May_2016.pdf).

308 Jennifer H. Svan Heath Druzin, “Military sees rise in eye injuries from lasers,” *Stars and Stripes*, June 14, 2009, <https://www.stripes.com/news/military-sees-rise-in-eye-injuries-from-lasers-1.92467>.

309 David Hambling, “The Secret History of Plasma Weapons,” *Popular Mechanics*, November 14, 2018, <https://www.popularmechanics.com/military/research/a25091957/plasma-weapon-history/>.



IMAGE LEFT: A POLICE OFFICER USES A TASER STUN GUN ON AN ANTI-GOVERNMENT PROTESTOR JUST OUTSIDE THE MEDIA CENTER FOR JOURNALISTS COVERING EVENTS RELATED TO WORLD YOUTH DAY, ON THE COPACABANA BEACHFRONT, IN RIO DE JANEIRO, BRAZIL, FRIDAY, JULY 26, 2013. VICTOR R. CAIVANO | AP PHOTO. IMAGE RIGHT: AN ISRAELI DRONE DROPS GAS CANISTERS ON PALESTINIAN PROTESTERS DURING A DEMONSTRATION AT THE DCO CHECKPOINT NEAR RAMALLAH, WEST BANK, PALESTINE. 30 JANUARY, 2020. PHOTO: OREN ZIV

surveillance and to carry and fire CCWs.<sup>310</sup> The use of ROVs to deploy surveillance technologies against protests and protesters<sup>311</sup> has increased sharply in recent years to the point that in many countries, it is now a routine element of law enforcement's response to demonstrations.<sup>312</sup> This raises concerns about ROVs being used to create a chilling effect on civil activism and infringe on the right to privacy of protesters and bystanders.<sup>313</sup> There was a consensus among the interviewed INCLO-affiliated civil liberties experts that the use of drone technology is *the* most concerning CCW development in the past five years. One expert noted that

drones are “regularly used in large cities for surveillance. We can’t confirm, but we speculate they are used for facial recognition because people are detained several days later after a rally.” Another noted, “They are always watching.”

The increased use of ROVs with the capacity or express design to be used as dispersal mechanisms raises many concerns, including potential violation of privacy rights and the possible indiscriminate use of CCWs fired from ROVs. An additional, less obvious concern is the potential reduction in the number of police physically present in crowd-

310 Omega Research Foundation, “Tear Gassing by Remote Control: The development and promotion of remotely operated means of delivering or dispersing riot control agents,” *Omega Research Foundation*, December 2015, <https://omegaresearchfoundation.org/sites/default/files/uploads/Publications/Tear%20Gassing%20By%20Remote%20Control%20Report.pdf>.

311 INCLO, “Spying on Dissent”, June 2019, accessible at: <https://www.inclo.net/pdf/spying-on-dissent-report.pdf>.

312 From interviews with civil liberties experts, October 2021 to March 2022.

313 General Comment No 37 below n 353 at para 10.

The first confirmed operational use of UAVs during demonstrations was by Israeli security forces, who have used them to drop tear gas grenades on protesters in the Gaza Strip, the West Bank, and Jerusalem.

control situations, with officers replaced by ROVs.<sup>314</sup> The judicious use of force is heavily dependent upon police judgement in these complex and dynamic settings. The removal of vital scene-specific context through the use of ROVs may lead to greater use of unnecessary or disproportionate force, likely with no feedback on the consequences of this use of force.<sup>315</sup>

### Mechanism of action

ROVS include unmanned aerial vehicles (UAVs, or “drones”). Since the mid-2010s, UAVs have possessed operational capabilities with clear application to crowd control, such as the capacity to fire CCWs,<sup>316</sup> OC spray,<sup>317</sup> and tasers.<sup>318</sup> There are also land-based, remotely operated vehicles that have not been

used in crowd-control settings. Israel has demonstrated their capability to drop “skunk water” from UAVs,<sup>319</sup> while South Africa has also pioneered the development of weapons for use on UAVs, including grenade delivery systems<sup>320</sup> and pepper-ball guns.<sup>321</sup>

Although the deployment of CCW drones has only been confirmed in Israel and the Occupied Palestinian Territories at the date of this report, there has been an increase in countries procuring these types of ROVs. In 2015, police in the Indian city of Lucknow announced they had acquired five pepper-spraying drones for crowd-control purposes.<sup>322</sup> In 2021, media reported that the Rapid Action Force, a wing of India’s Central Reserve Police Force specialised in crowd control, would deploy a suite of surveillance drones and at least one drone

314 Jay Stanley, “Five Reasons Armed Domestic Drones Are a Terrible Idea,” *ACLU*, August 27, 2015, <https://www.aclu.org/blog/privacy-technology/surveillance-technologies/five-reasons-armed-domestic-drones-are-terrible>.

315 Christian Enemark, “Armed Drones and Ethical Policing: Risk, Perception, and the Tele-Present Officer,” *Criminal Justice Ethics* 40, no. 2 (2021): 124-144 <https://www.tandfonline.com/doi/full/10.1080/0731129X.2021.1943844>.

316 See <https://www.youtube.com/watch?v=GafJexL9SjA&t=226s>.

317 BBC, “India: City police to use pepper-spray drones,” *BBC*, April 7, 2015, <https://www.bbc.com/news/blogs-news-from-elsewhere-32202466>.

318 Sam Biddle, “Startup Pitched Tasing Migrants From Drones, Video Reveals,” *The Intercept*, December 13, 2021, <https://theintercept.com/2021/12/13/brinc-startup-taser-drones-migrants/>.

319 See <https://twitter.com/MoDIIsrael/status/996735837541777408>.

320 “Skunk Riot Copter,” Desert Wolf, <https://ezone.idexuae.ae/storage/brochures/sdZtdPs512ER9vkcK7cfTicjPzwUSKcjaLh4dHkH.pdf>.

321 Guy Martin, “Desert Wolf adding grenades to Skunk riot control UAV,” *defenceWeb*, October 7, 2015, <https://www.defencewe.co.za/aerospace/aerospace-aerospace/desert-wolf-adding-grenades-to-skunk-riot-control-uav/>.

322 The Guardian, ‘Pepper-spraying drones could be used on unruly crowds by Indian police’, 8 April 2015, available here: <https://www.theguardian.com/world/2015/apr/08/pepper-spraying-drones-could-be-used-on-unruly-crowds-by-indian-police>.



capable of deploying tear gas during farmers' protests in New Delhi.<sup>323</sup> In the United States, local law enforcement agencies have expressed interest in equipping drones with CCWs. In 2011, Texas media reported that a county sheriff's department outside the city of Houston had acquired a \$300,000 ShadowHawk drone that, according to the manufacturer, includes capabilities to fire lethal and "less-lethal" weapons. In 2015, the state of North Dakota passed a bill permitting law enforcement drones to be equipped with "less than lethal" weapons (though the bill prohibits law-enforcement drones being equipped with lethal weaponry).<sup>324</sup>

The first confirmed operational use of UAVs during demonstrations was by Israeli security forces, who have used them to drop tear gas grenades on protesters in the Gaza Strip,<sup>325</sup> the West Bank,<sup>326</sup> and Jerusalem.<sup>327</sup> Within the Occupied Palestinian Territories, at least three types of drones deployed CCWs during sustained protests and conflict at the Gaza border in 2018. These include the Cyclone, which carries a set of light-weight aluminium cartridges that burn up after release; another

model that sprays gas directly from the craft, like an aerosol; and a third that drops "rubber bursting grenades with metal tops that disperse gas as they fall."<sup>328</sup>

The latest development for remotely operated crowd control technologies is a remote-operated shooter that was installed at a checkpoint in the West Bank city of Hebron/Al-Khalil in September 2022.<sup>329</sup> The system placed in Hebron/Al-Khalil was apparently created by "Smart Shooter", an Israeli company that designs fire control systems that follow and lock in on targets using image processing based on artificial intelligence.<sup>330</sup> Although the Israeli army has said that it plans to only use sponge bullets in the pilot phase, this technology is capable of firing different kinds of projectiles, including stun grenades and chemical irritants.

## Health concerns

Health concerns related to drone-deployed CCWs are directly linked to the type of weapon deployed and its impacts (as described

---

323 India Today TV, 'Farmer's tractor rally on Republic Day: RAF deploys anti-riot drone', 21 January 2021, available here: <https://www.indiatoday.in/india/story/farmer-s-tractor-rally-on-republic-day-raf-deploys-anti-riot-drone-1761481-2021-01-21>.

324 The Daily Beast, 'First state legalises taser drones for cops, thanks to a lobbyist', 26 August 2015, available here: <https://www.thedailybeast.com/first-state-legalizes-taser-drones-for-cops-thanks-to-a-lobbyist>.

325 Daniel Hilton, "Drones over Gaza: How Israel tested its latest technology on protesters," *Middle East Eye*, May 18, 2018, <https://www.middleeasteye.net/news/drones-over-gaza-how-israel-tested-its-latest-technology-protesters>.

326 Josh Breiner, "Israel Using Drones to Tear Gas Palestinian Demonstrators in West Bank," *Haaretz*, April 28, 2021, <https://www.haaretz.com/israel-news/.premium-israeli-police-using-drones-to-drop-tear-gas-on-palestinian-demonstrators-1.9752997>.

327 Josh Breiner et al., "Israel Police Use Drone to Fire Tear Gas Grenades in Temple Mount Clashes," *Haaretz*, 22 April 2022, <https://www.haaretz.com/israel-news/2022-04-22/ty-article/.premium/israel-police-use-drone-to-fire-tear-gas-grenades-in-temple-mount-clashes/00000180-655f-d5ca-a986-7f7fa1ad0000>.

328 The Middle East Eye, 'Drones over Gaza: How Israel tested its latest technology on protesters', 18 May 2018, available here: <https://www.middleeasteye.net/news/drones-over-gaza-how-israel-tested-its-latest-technology-protesters>.

329 Hagar Shefaz, "Israeli Army Installs Remote-control Crowd Dispersal System at Hebron Flashpoint," *Haaretz*, September 23, 2022, <https://www.haaretz.com/israel-news/2022-09-24/ty-article/.premium/israeli-army-installs-remote-control-crowd-dispersal-system-at-hebron-flashpoint/00000183-70c4-d4b1-a197-ffc4b24f0000>.

330 Smart Shooter website at <https://www.smart-shooter.com/>.

above). The utilisation of drones for weapon deployment may carry additional risks secondary to the lack of in-person monitoring, the height from which weapons are deployed, and changes in force or targeting from these weapons. There are concerns about the increased force of chemical irritant canisters that fall from great heights. Moreover, they may fall on protesters with no warning. These weapons may be far more indiscriminate in their deployment as visual feedback loops around the demonstration site will be limited. De-escalation could be rendered impossible if there are no officers with whom protesters can seek to communicate, and there could be challenges in allowing for the safe dispersal of demonstrators if airborne drones outmanoeuvre demonstrators. These concerns make the growing sale and early use of drone technology deeply concerning both from a health and human rights perspective.

Beyond any weaponry they may carry, drones themselves are increasingly causing injuries. They can cause injuries because of their function and mechanism: they can operate too close to the ground or hit objects and

fall. Additionally, their rotating blades, sharp edges, metallic and plastic parts, and rapid and unpredictable movements can injure both users and others in the vicinity. News and social media reports describe numerous injuries from drones: children, bystanders, and others have all been struck, leaving some with head trauma and others with permanent disability. A 2021 review of emergency department visits in the United States between 2015 and 2020 identified more than 3,700 drone-related injuries. The most common injury diagnoses were lacerations (72%), followed by contusion/abrasion (10%), strain/sprain (5%), and internal injury (5%). The most frequently injured body parts were upper extremities (mostly fingers [56%]), head (24%), lower extremities (14%), and trunk (6%). Hearing injuries have been reported as well. The US National Electronic Injury Surveillance System recommends avoiding injuries by taking care where the drone is flown and not flying a drone over a crowd, among other precautions.

IMAGE BELOW: ISRAELI TROOPS FIRE TEAR-GAS AT PALESTINIAN PROTESTERS DURING CLASHES AFTER PROTESTS NEAR THE BORDER WITH ISRAEL IN THE EAST OF JABALIYA IN THE NORTHERN GAZA STRIP, 14 MAY 2018. 51 PALESTINIANS PROTESTERS WERE KILLED AND MORE THAN 2000 OTHERS WERE INJURED DURING THE CLASHES ALONG THE BORDER BETWEEN ISRAEL AND GAZA STRIP. NIDAL ALWAHEIDI | PACIFIC PRESS/LIGHTROCKET VIA GETTY IMAGES



## Case study

# The first use of drone-deployed CCWs

## Gaza and Israel

Many CCWs used by the police within Israel have previously been tried by the military against the Palestinian population in the Occupied Territories. This was the case with sponge bullets and skunk water, and so it was with the use of tear gas fired from drones. The police “imported” this weapon in 2022 for use inside Israel after it had been used in the Occupied Territories since 2018.

The first widespread use of this weapon was in 2018 during the weekly Gaza border protests. Along with firing live ammunition that led to the killing of about 200 Palestinian protesters and the injury of thousands, drones were used to fire tear gas canisters indiscriminately at the protesters, with no distinction made between peaceful protesters, including children and elderly, and violent ones.<sup>331</sup> One foreign correspondent reported seeing a drone dropping tear gas about 500 metres beyond the Gaza border, above a communal tent occupied by women and children who were not engaged in protest.<sup>332</sup> The UN Commission of Inquiry into

the 2018 protests in Gaza found that a drone had dropped tear gas onto a field hospital that was clearly marked with medical insignia.<sup>333</sup>

Following its use against protesters in the Occupied Palestinian Territories, the Israeli police used drone-deployed tear gas for the first time against Israeli citizens in 2022. In January 2022, thousands gathered in the Negev region in southern Israel to protest the dispossession of Palestinian Bedouin citizens of Israel.<sup>334</sup> The Israeli police dispersed this demonstration brutally with sponge bullets, stun grenades, and tear gas launched from drones. In April and May 2022, the police used this weapon against Palestinian worshipers in the El-Aqsa mosque in Jerusalem in response to riots inside the mountain compound. The photos showed crowds of worshipers, including women, children, and the elderly,

331 The Times of Israel, ‘Israel deploys drones to drop tear gas on Gaza protesters,’ 31 March 2018, available here: <https://www.timesofisrael.com/israel-deploys-drones-to-drop-tear-gas-on-gaza-protesters/>.

332 The Middle East Eye, ‘Drones over Gaza: How Israel tested its latest technology on protesters’, 18 May 2018, available here: <https://www.middleeasteye.net/news/drones-over-gaza-how-israel-tested-its-latest-technology-protesters>.

333 UN Human Rights Council, Report of the detailed findings of the independent international Commission of inquiry on the protests in the Occupied Palestinian Territory (A/HRC/40/CRP.2) p 167, 18 March 2019. available here: [https://www.ohchr.org/EN/HRBodies/HRC/RegularSessions/Session40/Documents/A\\_HRC\\_40\\_74\\_CRP2.pdf](https://www.ohchr.org/EN/HRBodies/HRC/RegularSessions/Session40/Documents/A_HRC_40_74_CRP2.pdf); Al Jazeera, ‘Israeli forces open fire on Palestinians; hundreds wounded’, 9 July 2021, available here: <https://www.aljazeera.com/news/2021/7/9/israel-forces-open-fire-on-palestinians-hundreds-wounded>.

334 Haaretz ‘Bedouin Protest in Jerusalem Demands End of ‘Neglect’ in Israel’s South’ 30 January 2022. available at: <https://www.haaretz.com/israel-news/2022-01-30/ty-article/.premium/bedouin-protest-in-jerusalem-demands-end-of-neglect-in-israels-south/0000017f-e172-df7c-a5ff-e37ac2ae0000>.



PALESTINIANS CLASH WITH ISRAELI FORCES FROM ACROSS THE BORDER FOLLOWING A DEMONSTRATION, EAST OF RAFAH IN THE SOUTHERN GAZA STRIP, ON SEPTEMBER 6, 2019. ABED RAHIM KHATIB | SIPA USA VIA AP IMAGES

fleeing in all directions while multiple tear gas capsules were falling onto them from a drone.

The tear gas-carrying drone includes a camera and can carry multiple capsules and fire them all together or individually. Israeli security forces purchase the system from two Israeli companies: the gas capsules from ISGRA by E.I LTD and the system that fires the capsules from SPECIFY LTD.

This is a new weapon whose risks are still unclear. It is clear, however, that this

is a weapon that is inherently inaccurate, and it is doubtful whether it can be used proportionately. Another concern is that the capsules may fall directly onto protesters' heads or into their eyes. Especially when several capsules are used at the same time, the chance of harming peaceful protesters is very high. Finally, the aerial deployment of tear gas risks sowing confusion and chaos among crowds rather than fostering an orderly dispersal.<sup>335</sup>

---

335 The Middle East Eye, 'Drones over Gaza: How Israel tested its latest technology on protesters', (18 May 2018), accessible here: <https://www.middleeasteye.net/news/drones-over-gaza-how-israel-tested-its-latest-technology-protesters>.



# LAWS AND STANDARDS ON THE USE OF FORCE AND CROWD-CONTROL WEAPONS

NEW DELHI, INDIA-JAN 14 2020: MUSLIM WOMEN PROTEST THE CAA ACT DURING A SIT IN. PRADEEP GAURS | SHUTTERSTOCK

## Overview

Over the six years since the publication of LiD1, there has been a rapid development of international and regional laws and standards relating to the protection and promotion of assembly, association and free expression rights. These include new international laws and standards regulating the development, testing, trade, use and misuse of CCWs. Underpinned by existing, binding international instruments, these new laws and standards strengthen assembly, association and free expression rights, as well as rules on the use of CCWs in protest contexts. However, the implementation and adoption of these new laws and standards at the national level have been limited, severely

restricting the application of these rights in real-world protest contexts.

The most notable legal developments include the 2020 UN Guidance on LLWs,<sup>336</sup> which INCLO and PHR helped inform.<sup>337</sup> It provides detailed guidance on the principles concerning the lawful use of LLWs in policing, prohibitions on the use of certain LLWs, and instructions on the lawful deployment of LLWs in both protest and custodial settings. In addition, the UN Human Rights Committee—an authoritative body of legal experts mandated to monitor implementation of the International Covenant on Civil and Political Rights (ICCPR)—has produced two General Comments which, alongside various UN Human Rights Resolutions<sup>338</sup> and

336 See above n 6.

337 The UN Guidance on LLWs and other groups use the term less-lethal weapons (LLWs) while our report uses the term crowd-control weapons (CCWs). Our report uses the term CCW to avoid suggesting that these weapons are not dangerous. Lethality is based not only on the weapon profile but on how it is used. A more objective term in this sense is CCWs, as it covers all weapons used in assemblies. In the context of this section, and where necessary, we use LLW as that is the term the UN uses. In practice, they can be used interchangeably.

338 See, for example, UNHRC Res. 25/38 (2014) and UNHRC Res. 38/11 (2018).



regional standards, give further guidance to states and law enforcement on the assembly, association and free expression rights of protesters, and the lawful use of LLWs.

Despite this expansion of international legal standards, there is limited evidence of the implementation of these standards at the national level. Resultantly, consistent violations of human rights and civil liberties in protest contexts stubbornly persist and, in some instances, have increased over the past six years. There is no question that standard-setting at the international and regional levels is critically important. Equally essential, however, are local and national standard-setting efforts and the revision of policies, operational protocols, and training manuals for law enforcement officials to bring them in line with prevailing international norms. Monitoring and reporting on, and accountability for, the use of CCWs by law enforcement officials remains a key area of concern, despite clear international law guidance on the need to ensure oversight over policing operations in protest contexts.

Policy-makers, civil rights activists, and protesters must continue to work tirelessly to advocate for stronger laws and standards at the international level—including advocating for amending the Chemical Weapons Convention<sup>339</sup> to ban the use of chemical weapons against civilian populations and

supporting the development of a treaty to limit trade in the “tools of torture”—and ensure the domestication of these standards in order to bring meaningful change at the local and national levels, advance and develop assembly, association and free expression rights, and foster a culture of participation and dissent in democratic spaces.

## International human rights law

In the context of CCWs, the internationally recognised right to life and the right to freedom from torture or ill-treatment play foundational roles in the development of instruments that regulate the use of force and CCWs, as do assembly, association, and free expression rights contained in international conventions and treaties. They do so by placing an obligation on law enforcement officials to respect and protect life during their operations and to respect, protect, and fulfil assembly, association and free expression rights.

The right to life is recognised in article 6(1) of the International Covenant on Civil and Political Rights (ICCPR),<sup>340</sup> among other treaties.<sup>341</sup> The right to freedom from torture or ill-treatment is recognised in article 7 of the ICCPR, and it is further expounded upon in the Convention Against Torture and Other Cruel, Inhuman and Degrading Treatment or

---

339 Convention on the Prohibition of the Development, Production, Stockpiling and Use of Chemical Weapons and on their Destruction (Chemical Weapons Convention), (3 September 1992), accessible at: <https://legal.un.org/avl/ha/cpdpsucw/cpdpsucw.html>.

340 International Covenant on Civil and Political Rights, (16 December 1966), accessible at: <https://www.ohchr.org/en/professionalinterest/pages/ccpr.aspx>.

341 See, among others, the African Charter on Human and Peoples' Rights, ( 27 June 1981), accessible at <https://achpr.au.int/en/charter/african-charter-human-and-peoples-rights>.

Punishment (CAT).<sup>342</sup> In addition, the ICCPR, which constitutes binding international law on state parties, guarantees the rights to expression, assembly, and association in articles 19, 21, and 22.<sup>343</sup> These rights are equally provided for in binding regional treaties and place an obligation on law enforcement agencies to protect life and prohibit the excessive use of force during their operations.<sup>344</sup> Additional instruments, like the UN Guidance on LLWs, expand on this duty by regulating the use of force and CCWs.

## UN Human Rights Committee General Comment No 36

In 2018, the UN Human Rights Committee published General Comment No 36,<sup>345</sup> which elaborates on the right to life in the ICCPR. General Comments constitute the treaty body's authoritative interpretation of its respective human rights treaty provisions and are intended to give expert guidance on the fundamental rights contained in the ICCPR and other binding international treaties.

General Comment No 36 states that the deprivation of life should be interpreted broadly to include intentional or otherwise

foreseeable and preventable life-terminating harm or injury, caused by either an act or omission, and that the deprivation of life goes beyond injury or threats to bodily or mental integrity.<sup>346</sup> The obligation on states also extends to reasonably foreseeable life-threatening situations, including in protest contexts, even if those threats do not actually lead to a loss of life.<sup>347</sup>

The General Comment notes that any potentially lethal use of force for law enforcement purposes is an extreme measure that should be resorted to only when strictly necessary in order to protect life or prevent serious injury from an imminent threat.<sup>348</sup> States are expected to take all necessary measures to prevent arbitrary deprivation of life by their law enforcement officials, including soldiers charged with law enforcement missions. These preventative measures include:

- › **Appropriate legislation** controlling the use of lethal force by law enforcement officials.
- › **Procedures** designed to ensure that law enforcement actions are adequately planned in a manner consistent with

342 Convention Against Torture and Other Cruel, Inhuman and Degrading Treatment or Punishment; (10 December 1984), accessible at: <https://www.ohchr.org/en/professionalinterest/pages/cat.aspx>.

343 See above n 340.

344 Centre for Human Rights, University of Pretoria, Overview of Global and Regional Human Rights Standards on the Police Use of Force, (20 May 2020), accessible at: <https://www.ohchr.org/en/calls-for-input/general-comment-no-36-article-6-right-life>.

345 General Comment No 36 (2018) on article 6 of the International Covenant on Civil and Political Rights, on the right to life, adopted by the Human Rights Committee (General Comment No 36), accessible at: [https://tbinternet.ohchr.org/Treaties/CCPR/Shared%20Documents/1\\_Global/CCPR\\_C\\_GC\\_36\\_8785\\_E.pdf](https://tbinternet.ohchr.org/Treaties/CCPR/Shared%20Documents/1_Global/CCPR_C_GC_36_8785_E.pdf).

346 *Id* at para 6.

347 *Id* at para 7.

348 *Id* at para 12.

the need to minimise the risk they pose to human life.

- › **Mandatory reporting, review and investigation** of lethal incidents and other life-threatening incidents and supplying officials responsible for the management of assemblies with effective, less-lethal means and adequate protective equipment in order to obviate their need to resort to lethal force.<sup>349</sup>

In particular, the General Comment reaffirms that all operations of law enforcement officials should comply with relevant international standards, including the UN Code of Conduct for Law Enforcement Officials<sup>350</sup> (UN Code of Conduct) and the UN Basic Principles.<sup>351</sup> By way of key principles, the General Comment provides that:

- › States engaged in the **deployment, use, sale, or purchase of existing CCWs** and in the study, development, acquisition, or adoption of these weapons must always consider their impact on the right to life.<sup>352</sup>

- › CCWs must be subject to **strict independent testing and evaluation** in order to monitor their impact on the right to life<sup>353</sup>

- › CCWs must be restricted to law enforcement officials who have undergone **appropriate training** and must be strictly regulated in accordance with applicable international standards, including the UN Basic Principles.<sup>354</sup>

- › CCWs must be employed only subject to strict requirements of **necessity and proportionality**, in situations in which other less harmful measures have proven to be or clearly are ineffective.<sup>355</sup>

- › States should not resort to CCWs in situations of crowd control that can be addressed through **less harmful means**, especially situations involving the exercise of the right to peaceful protest.<sup>356</sup>

- › **Non-state actors**, such as privately-hired security officers, empowered or authorized by the state to employ force with potentially lethal consequences

349 *Id* at para 13.

350 United Nations Code of Conduct for Law Enforcement Officials, adopted by General Assembly resolution 34/169 of 17 December 1979 available at: <https://www.ohchr.org/en/professionalinterest/pages/lawenforcementofficials.aspx#:~:text=Law%20enforcement%20officials%20shall%20at,responsibility%20required%20by%20their%20profession>.

351 See above n 8.

352 *Id* at para 65.

353 *Id* at para 14.

354 *Id*.

355 *Id*.

356 *Id*.

are equally subject to the dictates of the General Comment.<sup>357</sup>

- › States must *investigate and prosecute unlawful deprivations of life*, such as allegations of excessive use of force with lethal consequences and the use of live fire against protesters.<sup>358</sup>

## UN Human Rights Committee General Comment No 37

In 2020, the UN Human Rights Committee produced General Comment No 37, which elaborates on the right to peaceful assembly in the ICCPR.<sup>359</sup> It states that the right to peaceful assembly is important in its own right. It also constitutes the foundation of participatory and democratic systems, and it is a tool to recognise many other rights. It constitutes an individual right that is exercised collectively.<sup>360</sup> Inherent in the right is an associative element but the right applies to individuals, and law enforcement officials must be cautious about viewing individual protesters as a group.

The General Comment directly addresses the issue of police use of force in the context of assemblies stating that:

All law enforcement officials responsible for policing assemblies must be suitably equipped, including where needed with appropriate and fit-for-purpose less-lethal weapons and protective equipment. States parties must ensure that all weapons, including less-lethal weapons, are subject to strict independent testing, and that officers deployed with them receive specific training, and must evaluate and monitor the impact of weapons on the rights of those affected.<sup>361</sup>

The General Comment also states that “law enforcement agencies must be alert to the potentially discriminatory impacts of certain policing tactics, including in the context of new technologies, and must address them.”<sup>362</sup> In general terms, General Comment 37 follows the principles stated in the UN Guidance on LLWs, which is discussed further below.

---

357 *Id* at para 15.

358 *Id* at paras 27 and 29.

359 General Comment No 37 (2020) on the right of peaceful assembly (article 21), adopted by the Human Rights Committee (General Comment No 37), accessible at: <https://daccess-ods.un.org/access.nsf/Get?OpenAgent&DS=CCPR/C/GC/37&Lang=E>.

360 *Id* at paras 1-2.

361 *Id* at para 81.

362 *Id*.

## Case study

# Police usage of KIPs during summer 2020 Black Lives Matter protests

## United States

The murder of George Floyd on 25 May 2020, after a Minneapolis police officer knelt on his neck for 9 minutes and 29 seconds, sparked nationwide protests against police brutality. In June 2020, about 15 to 26 million people participated in BLM protests, making it one of the largest protest movements in US history.<sup>363</sup>

Law enforcement agencies indiscriminately deployed CCWs, including KIPs, such as foam/sponge bullets, rubber bullets, pepper balls, beanbag rounds, chalk grenades and flashbang grenades against protesters, the vast majority of whom were peacefully assembled. Countless protesters, bystanders and journalists sustained critical wounds, broken bones, traumatic brain injuries and even blindness as a result of the projectiles fired by police.<sup>364</sup> In just one day, 30 May 2020, police partially blinded eight people across the country.<sup>365</sup>

There were more than 950 incidents of police violence against civilians recorded during the

protests that followed the murder of George Floyd.<sup>366</sup> These instances are symptomatic of the differentiated police response to those protesting racism and police brutality and illustrate the disproportionate impact of the violent policing on people of African descent and other people of colour. Moreover, while covering these protests, journalists became targets for assault and arrest by police officers. The violent and militarized response to BLM protesters stood in stark contrast to the largely passive police response to the violent insurrection by a white supremacist at the US Capitol on 6 January 2021.

### Foam/sponge bullets

In May 2020, the Minneapolis Police and the Minnesota State Patrol tear-gassed, peppersprayed, shot in the face with rubber and foam bullets, arrested without cause, and threatened journalists at gunpoint, all after these journalists identified themselves and were clearly covering BLM protests. Linda Tirado, a freelance photographer, was one of

363 L Buchanan, Q Bui and JK Patel, "Black Lives Matter May Be the Largest Movement in U.S. History," *The New York Times*, (3 July 2020), accessible at: <https://www.nytimes.com/interactive/2020/07/03/us/george-floyd-protests-crowd-size.html>.

364 L Szabo, J Hancock, K McCoy, D Slack and D Wagner, "Fractured Skulls, Lost Eyes: Police Break Their Own Rules When Shooting Protesters With 'Rubber Bullets,'" *USA Today News*, (19 June 2020), accessible at: <https://www.usatoday.com/in-depth/news/nation/2020/06/19/police-break-rules-shooting-protesters-rubber-bullets-less-lethal-projectiles/3211421001/>.

365 M Kelly, J Sohyun Lee and J Swaine, "Partially Blinded by Police," *The Washington Post*, (14 July 2020), accessible at: <https://www.washingtonpost.com/investigations/2020/07/14/george-floyd-protests-police-blinding/>.

366 T Thomas, A Gabbat and C Bar, "Nearly 1,000 Instances of Police Brutality Recorded in US Anti-Racism Protest," *The Guardian*, (20 October 2020), <https://www.theguardian.com/us-news/2020/oct/29/us-police-brutality-protest>.





POLICE AND FEDERAL AGENTS USED TEAR GAS, PEPPER BALL, AND RUBBER BULLET WEAPONRY AGAINST PROTESTORS IN PORTLAND, OREGON, UNITED STATES IN JULY 2020. ANDREW STANBRIDGE | PHYSICIANS FOR HUMAN RIGHTS

the many people severely injured.<sup>367</sup> Despite being clearly identifiable as a member of the press, on 29 May 2020, an officer shot a 40mm impact foam bullet round at her head.<sup>368</sup> Tirado was permanently blinded in her left eye and suffered traumatic brain injury,<sup>369</sup> and has undergone multiple eye surgeries to address ongoing complications.<sup>370</sup> As a result of the attack, Tirado still suffers from constant headaches, has trouble recalling words, and uses a walker due to her loss of

depth perception. In June 2020, the ACLU of Minnesota filed a lawsuit on behalf of Tirado and other journalists targeted in the BLM protests<sup>371</sup> that resulted in a settlement agreement which included various policy changes, including prohibiting the arrest, threat or use of physical force or chemical agents against journalists.<sup>372</sup>

367 L Reyes, "Journalists Blinded, Injured, Arrested Covering George Floyd Protests Nationwide," USA Today, (31 May 2020), accessible at: <https://www.usatoday.com/story/news/nation/2020/05/31/journalists-blinded-injured-arrested-covering-george-floyd-protests/5299374002/>.

368 *Tirado v City of Minneapolis*, 521 F. Supp. 3d 833 (D. Minn. 2021), accessible at: <https://www.documentcloud.org/documents/20491477-2021-02-22-memorandum-opinion>.

369 T Webster, "Minneapolis Settles Lawsuit With Linda Tirado, Journalist Blinded In One Eye During May 2020 Unrest," Minnesota Reformer, (26 May 2022), accessible at: <https://minnesotareformer.com/2022/05/26/minneapolis-settles-lawsuit-with-linda-tirado-journalist-blinded-in-one-eye-during-may-2020-unrest/>.

370 See above n 362.

371 See <https://www.aclu-mn.org/en/cases/jared-goyette-et-al-v-city-minneapolis-et-al>.

372 *Goyette v City of Minneapolis*, 20-CV-1302 (WMW/DTS), 2022 WL 370161 (D. Minn. Feb. 8, 2022), accessible at: <https://www.aclu-mn.org/en/press-releases/goyettesettlement>.

## Rubber bullets and pepper balls

In Denver, Colorado, protesters and bystanders were injured by rubber bullets and pepper balls deployed by law enforcement. Michael Driscoll filed a civil rights lawsuit after he was struck in the face with a rubber bullet shot by police on 30 May 2020.<sup>373</sup> The impact shattered his sinus and fractured multiple parts of his face, including the orbital bone around his left eye. Driscoll was forced to undergo surgery to reconstruct his skull, which had collapsed between his eyes. Bystander Jax Feldman was struck in the eye with a pepper ball launcher when walking home near a protest and permanently blinded in one eye.<sup>374</sup>

In a landmark lawsuit brought by the ACLU of Colorado and two law firms, a federal jury held the city of Denver accountable for its response to the BLM protests and in March 2022 awarded \$14 million to twelve protesters injured by rubber and foam bullets, pepper balls, flash bang grenades, and tear gas while protesting police violence. The lawsuit was the first lawsuit in the US challenging the use of force by police against protesters to go to

trial, and it also marks the first time that a jury held a city liable for violating the civil rights of protesters.

## Beanbag rounds

In Austin Texas, Justin Howell, a 20-year-old protester, was severely injured by a beanbag round during a protest against police brutality in late-May 2020.<sup>375</sup> An officer was allegedly shooting beanbag ammunition at a protester who was throwing objects at police, but instead inadvertently struck Howell in the middle of his forehead.<sup>376</sup> Howell suffered from a fractured skull and brain damage. Police continued to fire beanbag rounds at volunteer medics and protesters who were carrying Howell to safety. Meredith Michael, a volunteer medic wearing a firefighter shirt with a red medical cross sewed on, was shot in the hands and suffered severe injuries.<sup>377</sup> Both Michael and Howell sued the city and later reached a settlement.<sup>378</sup>

## Flash-bang grenades

In Santa Rosa, California, Marqus Martinez was peacefully taking a knee with his hands in the air when officers began firing tear gas,

---

373 *Driscoll v City of Denver*, Case No. 1:21-cv-02866 (25 October 2021), accessible at: <https://kdvr.com/wp-content/uploads/sites/11/2021/10/Driscoll-Complaint-2.pdf>.

374 S Towle and B Miller, "Attorneys For Denver Man Shot In Eye By Officers During Protests Call For Criminal Investigation, Settlement," Denver7, (15 June 2020), accessible at: <https://www.thedenverchannel.com/news/local-news/attorneys-for-denver-man-shot-in-eye-by-officers-during-protests-call-for-criminal-investigation-settlement>.

375 J McCullough, "Black Protester Who Was Critically Injured By Police In Protest Is Identified, Student Newspaper Reports," The Texas Tribune, (1 June 2020), accessible at: <https://www.texastribune.org/2020/06/01/austin-police-george-floyd-mike-ramos/>.

376 A Jamieson, "A College Student's Family Say He Has Brain Damage After Police Shot Him With A Beanbag Round," Buzzfeed News (4 June 2020), accessible at: <https://www.buzzfeednews.com/article/amberjamieson/justin-howell-protester-shot-head-police-austin-beanbag>.

377 *Id.*

378 A Weber, "Austin Oks \$850,000 Settlement For Volunteer Medic Shot With 'Less-Lethal' Ammunition During Protest," Austin Monitor, (6 May 2022), accessible at: <https://www.austinmonitor.com/stories/2022/05/austin-oks-850000-settlement-for-volunteer-medic-shot-with-less-lethal-ammunition-during-protest/>.

rubber bullets and flash-bang grenades at protesters. Police hit Martinez in the face with a flash-bang grenade<sup>379</sup> which broke Martinez's jaw in multiple locations and split his upper lip in three places up to his nose. His teeth also broke off and drove into the roof of his mouth and through his tongue.<sup>380</sup> Martinez still requires numerous surgeries to repair the extensive damage caused to his face. The city of Santa Rosa settled a lawsuit brought by Martinez and four others injured, agreeing to pay \$1.9 million.

### Tear gas canisters

In Fort Wayne, Indiana, 21-year-old protester, Balin Brake, lost his eye after being hit in the face by a tear gas canister while participating in a racial justice protest on 30 May, 2020.<sup>381</sup> Brake suffered two eyelid lacerations, four occipital fractures, and permanent loss of vision and light perception in his right eye.<sup>382</sup> The impact completely ruptured Brake's eye, which had to be surgically removed and replaced with a prosthetic eye. Following the incident, Brake continues to experience severe headaches, pain where his eye once was, loss of depth perception and mental suffering. The lawsuit was settled in March 2022.<sup>383</sup>

There were more than 950 incidents of police violence against civilians recorded during the protests that followed the murder of George Floyd.

---

379 K Bryant, "Santa Rosa Police Sued for Brutality Against BLM Protestors," Top Class Actions, (25 June 2020), accessible at: <https://topclassactions.com/civil-rights/santa-rosa-police-sued-for-brutality-against-blm-protesters/>.

380 *Martinez v City of Santa Rosa*, 2020 WL 9762698 (N.D.Cal.) (23 June 2020), accessible at: <https://turtletalk.files.wordpress.com/2020/06/1-complaint-8.pdf>.

381 J Stanton, "Demonstrator, 21, loses an EYE after being struck in the face by a police tear gas canister while peacefully protesting death of George Floyd in Indiana," Daily Mail, (31 May 2020), accessible at: <https://www.dailymail.co.uk/news/article-8374743/Demonstrator-21-loses-EYE-struck-face-police-tear-gas-canister.html>.

382 *Brake v City of Fort Wayne*, Case No. 1:20-cv-00345 (2 October 2022), accessible at: [https://www.aclu-in.org/sites/default/files/field\\_documents/brake\\_v\\_ftwayne\\_-\\_complaint.pdf](https://www.aclu-in.org/sites/default/files/field_documents/brake_v_ftwayne_-_complaint.pdf).

383 D Rowley, "Settlement Reached Between City Of Fort Wayne And Protester Who Lost Eye," Wane Local News, (5 March 2022), accessible at: <https://www.wane.com/news/local-news/settlement-reached-between-city-of-fort-wayne-and-protester-who-lost-eye/>.

## International standards and best practices

A series of codes of conduct, basic principles, and guidelines have also been developed, which apply directly to questions on the use of force in protest contexts, including CCWs.

### UN Code of Conduct

The UN Code of Conduct,<sup>384</sup> adopted by the General Assembly of the United Nations in 1979, is recognised as one of the foundational instruments on the use of force by law enforcement agencies.<sup>385</sup> It defines law enforcement agencies to include all officers of the law who exercise police powers, including military authorities and state security forces when exercising police powers, and recognises that law enforcement officials may use force in circumstances where it is strictly necessary—for the prevention of a crime or to effect a lawful arrest—but its use must be *exceptional*.<sup>386</sup> It further requires that national legislation must be enacted to ensure compliance with the principle of proportionality which directs that the use of force must be proportionate to its objective.

### UN Basic Principles

In addition to the UN Code of Conduct, the UN Basic Principles,<sup>387</sup> adopted in 1990, is also recognised as one of the foundational instruments on the use of force. It recognises the important role that law enforcement agencies play in the protection of the right to life, liberty, and security of the person<sup>388</sup> and requires that governments adopt and implement rules concerning the use of force in domestic law.<sup>389</sup> The UN Basic Principles include specific references to CCWs.

Notably, the UN Basic Principles require states to:

- › Equip law enforcement officials with a variety of different weapons that allow for a differentiated use of force, which may include the development of CCWs.<sup>390</sup>
- › Evaluate the development and deployment of CCWs to mitigate the risk of injury to bystanders and ensure that “the use of such weapons should be carefully controlled.”<sup>391</sup>
- › Use non-violent means before resorting to the use of force; the use of force may only be used if other

---

384 See above n 350.

385 See above n 345 at 1.

386 Article 2(a), Commentary on the UN Code of Conduct.

387 UN Basic Principles, above n 8.

388 *Id* at preamble.

389 *Id* at principle 1.

390 *Id* at principle 2.

391 *Id* at principle 3.

means are ineffective in achieving the intended result.<sup>392</sup>

- › Ensure that when the use of force is required, restraint is exercised in such use and officials act in proportion to the seriousness of the offence and the legitimate objective to be achieved, minimise damage and injury, respect and preserve human life, ensure that assistance and medical aid are rendered to any injured or affected persons at the earliest possible moment, and ensure that relatives or close friends of the injured or affected person are notified at the earliest possible moment.<sup>393</sup>
- › Criminalise the arbitrary or abusive use of force in domestic criminal law.<sup>394</sup>
- › Ensure that in the dispersal of protests, law enforcement officials avoid the use of force or, where that is not practicable, restrict such force to the *minimum extent necessary*<sup>395</sup> and that law enforcement officials may use firearms only when less dangerous means are not practicable and only to the minimum extent necessary.<sup>396</sup>

## UN Guidance on LLWs

The primary international law document on CCWs is the 2020 UN Guidance on LLWs.<sup>397</sup> While technically non-binding, it was published by the UN Office of the High Commissioner for Human Rights and was prepared by an international group of experts. It was informed by an extended and broad public participation process carried out under the auspices of the Geneva Academy and the University of Pretoria, which included states, academics and academic institutions, policing institutions, civil society organisations and activists.<sup>398</sup> INCLIO and PHR were actively involved in this process, based on our research in LiD1.

As a result, the UN Guidance on LLWs is highly persuasive and consolidates the most up-to-date and comprehensive international thinking on the development, testing, deployment, use and trade in CCWs. It substantially clarifies both the UN Code of Conduct and the UN Basic Principles, which, to some extent, lack specificity.

The UN Guidance on LLWs acknowledges the lack of clear directives concerning the deployment of CCWs in compliance with human rights law<sup>399</sup> and aims to supplement

392 *Id* at principle 4.

393 *Id* at principle 5.

394 *Id* at principle 7.

395 *Id* at principle 13.

396 *Id* at principle 14.

397 UN Guidance on LLWs, see above n 6.

398 For more information, see Geneva Academy, United Nations Human Rights Guidance on Less-Lethal Weapons, accessible at: <https://www.adh-geneve.ch/research/publications/detail/500-united-nations-human-rights-guidance-on-less-lethal-weapons-in-law-enforcement>.

399 UN Guidance on LLWs above n 6 at page v..



existing standards codified in the UN Code of Conduct and the UN Basic Principles. It does so by providing guidance on the responsible and lawful use of CCWs and stipulates the circumstances under which such weapons may be deployed. It also goes beyond the use of CCWs and provides guidance on their design, production, procurement, testing and training. It applies to the acts of all law enforcement officials at all times, including during counterterrorism activities, extraterritorially, and during instances of internal disturbances, including riots and acts of violence. It also applies to military personnel when they are acting in the capacity of law enforcement officials.

Importantly, the UN Guidance on LLWs recognises the misuse of CCWs and their potential to inflict serious or lethal harm, reinforcing some of the recommendations contained in LiD1. Specifically, it acknowledges that killings and torture, which are serious violations of international law, have previously been committed by using CCWs improperly.<sup>400</sup> It also notes that CCWs may be used to reduce the risk of serious harm in one of two circumstances: either as a less dangerous alternative to a firearm, or in a circumstance where the use of force is

necessary but the use of a firearm would not be lawful.<sup>401</sup>

## The “six principles”

The UN Guidance on LLWs reaffirms the principle that all law enforcement officials must respect and protect fundamental human rights, particularly in circumstances that may require the use of force.<sup>402</sup> It provides that force may only be used as a last resort, after using nonviolent means, and only if alternative measures appear ineffective.<sup>403</sup> *Any use of force must comply with the principles of legality, precaution, necessity, proportionality, nondiscrimination and accountability.*<sup>404</sup>

- › **Legality:** The principle of legality requires that rules concerning the use of force must be regulated in domestic law.<sup>405</sup> Law enforcement officials must act in compliance with such laws and the use of force may only be justified when it is used in pursuit of a *legitimate objective*.<sup>406</sup> Importantly, it provides that the use of force must never be used punitively.<sup>407</sup> The Guidance mandates that only authorized CCWs and related equipment can be used under specific conditions and that domestic laws must

400 *Id* at page iii.

401 *Id* at page 1.

402 *Id* at principle 2.1.

403 *Id* at principle 2.2.

404 *Id* at principle 2.3.

405 *Id* at principle 2.4.

406 *Id*.

407 *Id*.

impose limitations for minimizing the risk of injury.<sup>408</sup> The principle further requires that legislative instruments be sufficiently clear to ensure legal certainty and they must be widely published to enable accessibility.

- › Precaution: The principle of precaution requires that the planning and execution of law enforcement operations should aim to avoid the use of force and minimise the severity of injury.<sup>409</sup> It provides that law enforcement officials should delay contact with protesters if doing so poses no risk and would decrease the possibility of requiring the use of force or violence. The principle also acknowledges the value of precautionary measures such as training and the provision of appropriate protective equipment and CCWs. It further requires that due consideration be accorded to the consequences of the use of force and CCWs on vulnerable members of society. The Guidance considers the following persons to be vulnerable: “children, pregnant women, the elderly, persons with disabilities, persons with mental health problems and persons under the influence of drugs or alcohol.”<sup>410</sup>
- › Necessity: In terms of the principle of necessity, law enforcement officials may only use force when it is *strictly*

*and absolutely necessary* in order to achieve a legitimate law enforcement objective.<sup>411</sup> Necessity requires that no reasonable alternative to the use of force exists. The principle places an obligation on law enforcement officials to deescalate situations and to seek a peaceful resolution where possible. Further, the principle directs that in circumstances where the use of force is necessary, the least amount of force must be used, and must not persist beyond what is required.

- › Proportionality: The principle of proportionality requires that any use of force and its consequent harm must be proportionate to the threat posed by any person or potential offence. The use of force must not exceed its intended objective. The principle further places an obligation on law enforcement officials to minimise the potential for their use of force to harm “bystanders, passers-by, medical personnel and journalists.”<sup>412</sup>
- › Non-discrimination: The principle of non-discrimination places an onus on law enforcement officials to not discriminate against any person on one of the listed grounds. The grounds are non-exhaustive and include “race, ethnicity, colour, sex, sexual orientation, language, religion, political or other

---

408 *Id* at principle 2.5

409 *Id* at principle 2.6.

410 *Id* at principle 2.7.

411 *Id* at principle 2.8.

412 *Id* at principle 2.10.

opinion, national or social origin, disability, property or birth.”<sup>413</sup> To comply with this principle, law enforcement officials must exercise a heightened level of care concerning individuals who are likely to be more vulnerable to a particular weapon. Doing so requires active monitoring of the use of force.

- › **Accountability:** The Guidance reaffirms the principle that law enforcement officials must be held accountable for their actions, which includes their use of force as well as acts of omission, i.e., where law enforcement officials fail to meet their duty to protect members of the public.<sup>414</sup> The Guidance recognises the role played by additional actors in ensuring accountability—including members of the judiciary, civil society and human rights organisations. Accountability is enabled through effective monitoring, reporting and transparency. The principle also places an obligation on law enforcement agencies to establish internal accountability mechanisms that are effective and independent and recommends that states establish an external body that is appropriately resourced and able to provide an oversight function.<sup>415</sup>

Notably, the Guidance recommends that all law enforcement officials should be identifiable, all weapons should be marked, the allocation of weapons should be recorded, and incidents of the use of force should be reported.<sup>416</sup> Such reporting should include sufficient detail to determine whether the use of force complies with the principles. The Guidance provides that in the event of death or injury as a result of CCWs, the incident should be reported to the officer’s superiors and a competent authority. Such authority must be authorised to conduct an investigation into the instance. If the outcome of an investigation concludes that death or injury was caused unlawfully, states must ensure that perpetrators are prosecuted and punished, if found guilty. Every law enforcement official is responsible for his or her decision.<sup>417</sup> Importantly, the Guidance provides victims with a right to a remedy which may include “compensation, guarantees of non-repetition, rehabilitation, reparation, restitution and satisfaction.”<sup>418</sup>

---

413 *Id* at principle 2.11.

414 *Id* at principle 3.1.

415 *Id*.

416 *Id* at principle 3.3.

417 *Id* at principle 3.7.

418 *Id* at principle 3.12.

## Additional considerations

The UN Guidance on LLWs provides further direction concerning the design and production of CCWs and considerations on legal review, testing and procurement, monitoring, transparency and training. Significantly less detail is provided on these topics, but the broad principles are outlined below:

- › Design and production: The Guidance places an obligation on states *and private companies* to design and produce CCWs and equipment that meets lawful law enforcement objectives and complies with human rights law.<sup>419</sup> Identified risks must be communicated to the user, purchaser and the general public, and there should be greater transparency concerning the specifications of the weapon. The Guidance further notes that the design and production of CCWs should duly consider the limitations constraining the use of force remotely.
- › Legal review, testing and procurement: The Guidance directs that before procuring CCWs, states must conduct a legal review to determine whether it would be prohibited by any domestic or international law, specifically any provision of human rights law.<sup>420</sup> Such a review should include testing conducted by an independent party to assess the capability and potential consequences of the weapon. Testing should be conducted in accordance with a set of generally accepted standards and must consider the impact of the weapon on vulnerable individuals. Weapons that do not comply with the principles outlined in the Guidance should not be procured.
- › Monitoring: An obligation is placed on states and law enforcement agencies to monitor the deployment of CCWs.<sup>421</sup> The process should capture the circumstances of each use and the details of the people against whom force is used. It should also include spotchecks on CCWs. The results of the monitoring should be made publicly available.
- › Transparency: The Guidance provides that states and law enforcement agencies should be transparent concerning the use and regulation of CCWs.<sup>422</sup> It further provides that the anonymity of law enforcement officials may be protected in some instances, but it may not justify the non-publication of data.
- › Training: Training for law enforcement officials on the use of force is also prescribed.<sup>423</sup> Training should include

419 *Id* at principle 4.1.1.

420 *Id* at principle 4.2.1.

421 *Id* at principle 4.3.1.

422 *Id* at principle 4.4.1.

423 *Id* at principle 4.5.1.

a focus on the applicable human rights standards and techniques to de-escalate situations, including mediation, communication and identification of the vulnerabilities of certain groups of people. The training should be updated where necessary, and law enforcement officials should receive periodic refresher training.

- › Medical assistance: The Guidance reaffirms the principle that medical assistance should be provided to any person as soon as possible and without discrimination.<sup>424</sup> It provides that law enforcement officials should

be equipped with medical equipment and should fully cooperate with medical personnel.

- › Transfer and international cooperation: Concerning the transfer of CCWs, the Guidance provides that States shall regulate export and import of CCWs and related equipment in line with their international obligations.<sup>425</sup>

---

424 *Id* at principle 4.6.1.

425 *Id* at principle 4.7.1.

### Case study

## Venom launchers, a dangerous new technology used by police during 2021 social protests

### Colombia

Between 28 April and 30 June 2021, a national strike occurred in Colombia. This strike was called by different sectors and social movements (trade unions, students, indigenous people and youth, among others) because of “public discontent over a tax reform proposal, the economic and health crises in the context of COVID-19 and the increase in massacres and assassinations of

social leaders and human rights defenders from across the country.” The strike was impactful at the national level and was harshly repressed by the security forces. Although Colombian government accounts reported that the protests were largely peaceful, official figures recorded 59 protest-related deaths by the end of May 2021. The Venom launcher system (Venom) was one of several





RIOT POLICE (ESMAD) TRY TO DISBAND DEMONSTRATORS WITH TEAR GAS AND STUNT GRANADES IN PASTO, NARIÑO ON MAY 26, 2021 AT THE START OF THE 4TH WEEK OF ANTI GOVERNMENT PROTESTS IN COLOMBIA THAT HAVE RESULTED IN AT LEAST 40 DEAD IN POLICE ABUSE OF AUTHORITY CASES AND UNREST. CAMILO ERASSO | LONG VISUAL PRESS/UNIVERSAL IMAGES GROUP VIA GETTY IMAGES

weapons and equipment used by Colombian security forces during the policing of the 2021 protests.

Venom is a multi-tube grenade launcher which is either mobile (mounted on a vehicle) or static (placed on the ground). It includes up to 30 tubes (smaller models are available) that can fire different grenades or canisters (for example, 38mm, 40 mm or 66mm). The tubes on the launcher are fixed, which means that while the system can generally be aimed in a particular direction, the angle of elevation cannot be altered. Security forces were documented placing the Venom system on the ground, holding it by hand,

and firing directly at protesters rather than overhead.<sup>426</sup> Such use would be expected to cause movement of the launcher on firing, resulting in poor aiming or flat and direct firing trajectory. For law enforcement, the Venom 38mm munitions are advertised as having a range of between 100 and 160 meters.<sup>427</sup>

Venom is an inaccurate weapon which fires numerous canisters at the same time or successively in different directions. In addition, the canisters are fired at high velocity to long distances, which turns the canisters into KIPs. These features turn Venom into a dangerous weapon that can never comply with the principles of legality, precaution,

426 Temblores, Indepaz and PAIS, "Informe de Temblores, Indepaz y Pais a la CIDH sobre las violaciones a los derechos humanos cometidas por la fuerza pública contra la población civil colombiana en el marco del Paro", (June 2021), accessible at: <http://www.derechos.org/nizkor/////colombia/doc/duque54.html#disparos>.

427 Combined Systems Inc, CSI The Less-Lethal Product Source, product catalogue, available at: <https://www.combinedsystems.com/download-our-catalog/>.

and proportionality. Some weapons have no place in the policing of protest.

As of mid-June, NGOs Temblores, Indepaz and PAIS reported that they had recorded 28 instances where Venom had been used against protesters. In one instance of use in Bogotá, it was reported that “at least 20 detonations were counted in less than 10 seconds”. Newspaper *El Espectador* reported multiple uses of Venom, firing both stun grenades and tear gas towards protesters in Bogotá. The use was described as “flashes and sparks (like missiles), then thunderous explosions, ending in a rain of tear gas that filled the streets” which appeared to be “heavy artillery” and “indiscriminate”.<sup>428</sup> Video footage indicated significant numbers of cartridges being fired in quick succession. This type of use may cause panic among people in a crowd, risking a stampede, which may itself cause injuries, in addition to those caused by the impact or effects of the projectiles.

Use of Venom in the city of Popayán has been widely reported. France24 reported that “security forces fired the grenade launcher several times at protesters, who [were] located less than 80 metres away. Most of the protesters [were] sheltered behind shields and barricades.” In a joint report, Temblores, Indepaz and PAIS noted that one of the incidents in Popayán on 12 May 2021 was the first clear and recorded use

of Venom being placed on the ground and held by police officers and fired directly at protesters. Several reports document similar instances where Venom was fired directly at crowds, rather than overhead.

On 14 May 2021, Sebastián Quintero Múnera, a young protester, was killed during protests in Popayán. Múnera was allegedly killed by a Venom projectile. At the time of his death, Venom was being used by security forces on the streets of Colombian cities to disperse protesters. Its use was suspended by an administrative judge in Popayán in June 2021, although only in that city. The suspension is to be maintained until a protocol for its use is developed as “the way it is being used, can make it lethal”.

Following Múnera’s death, the Inter-America Commission on Human Rights (IACHR) called on the Colombian government to respect life and human rights, and warned against the indiscriminate use of CCWs, particularly noting “anti-riot weapons—like the Venom rocket launcher—that have an indiscriminate impact on mostly peaceful protests”.<sup>429</sup>

There is no evidence that Venom has been permanently retired from its use in Colombian law enforcement. Use of military-designed weapons, such as Venom, to police protests is indicative of a worrying trend towards violently suppressing the right to protest and freedom of expression.

428 *El Espectador*, ‘Venom: el arma en la tanqueta del Esmad, que causó pánico en el sur de Bogotá, en el Paro Nacional’, (5 May 2021), accessible at: <https://www.elespectador.com/bogota/venom-el-arma-en-la-tanqueta-del-esmad-que-causo-panico-en-el-sur-de-bogota-en-el-paro-nacional-article/>.

429 Organization of American States, “IACHR Condemns Serious Human Rights Violations in the Protest Context in Colombia, Rejects All Forms of Violence, and Stresses that the State Must Comply with its International Obligations”, (25 May 2021), accessible at: [http://www.oas.org/en/iachr/jsForm/?File=/en/iachr/media\\_center/preleases/2021/137.asp](http://www.oas.org/en/iachr/jsForm/?File=/en/iachr/media_center/preleases/2021/137.asp).

## Sidebar

## Manufacture and procurement of Venom

Developed by Combined Systems Inc (CSI), a US-based company, Venom is described as “a lightweight, high capacity, non-lethal grenade launcher”.<sup>430</sup> According to CSI’s marketing materials, Venom “delivers non-lethal flash and sound, smoke obscuration, irritant and blunt trauma effects”.<sup>431</sup> Initially, Venom was created for use by the United States Marine Corps, but not used by them. It has also been used for more than a decade by the Israeli army in the West Bank.<sup>432</sup>

reportedly cost the Colombian government between 400 million and 445 million pesos, although the precise figure is unclear.<sup>434</sup> In addition to the system itself, the Colombian government purchased cartridges from CSI for Venom, including, for example, signing a 745 million pesos contract for stun and tear gas cartridges.<sup>435</sup> In 2020, the Colombian Ministry of Defense stated that Venom cost the Colombian government \$118,000, with each launched cartridge valued at \$71.<sup>436</sup>

In Colombia, Combined Systems Inc has reportedly supplied a range of munitions to the Colombian “riot control” agency, ESMAD (Escuadrón Móvil Antidisturbios or the Mobile Anti-Disturbance Squadron).<sup>433</sup> Venom has

430 Combined Systems Inc, Venom, accessible at: <https://www.combinedsystems.com/Venom/>.

431 Combined Systems Inc, Venom®, accessible at: <https://www.combinedsystems.com/Venom/>.

432 B’Tselem, “Crowd Control: Israel’s Use of Crowd Control Weapons in the West Bank”, (January 2013) at p 13, accessible at: [https://www.btselem.org/download/201212\\_crowd\\_control\\_eng.pdf](https://www.btselem.org/download/201212_crowd_control_eng.pdf).

433 For more information on this relationship and the weapons and equipment in question, see Omega Research Foundation, “Tools of torture and repression in South America: Use, manufacture and trade”, (2016), accessible at: <https://omegaresearchfoundation.org/publications/tools-torture-and-repression-south-america-use-manufacture-and-trade-july-2016>. See, also, Dirección General de la Policía Nacional, Proceso Número PN DIRAF CD 144 2013, accessible at: <https://www.contratos.gov.co/consultas/detalleProceso.do?numConstancia=13-12-1984581>; Colombia Licita, Antimotín importado – PONAL: ADQUISICION EQUIPO ANTIMOTIN IMPORTADO, (2022), accessible at: <https://colombialicita.com/licitacion/1919>; and Cuestión Pública, “Los millonarios contratos de armas ‘no letales’ para la Policía y el Esmad”, (6 February 2021), accessible at: <https://cuestionpublica.com/los-millonarios-contratos-de-armas-no-letales-para-la-policia-y-el-esmad/>.

428 El Espectador, “Venom: el arma en la tanqueta del Esmad, que causó pánico en el sur de Bogotá, en el Paro Nacional”, (5 May 2021), accessible at: <https://www.elespectador.com/bogota/venom-el-arma-en-la-tanqueta-del-esmad-que-causo-panico-en-el-sur-de-bogota-en-el-paro-nacional-article/> and Contagioradio, “Venom: una de las costosas armas del ESMAD”, (9 May 2020), accessible at: [https://www.contagioradio-com.translate.google.com/venom-una-de-las-costosas-armas-del-esmad/?x\\_tr\\_sl=auto&x\\_tr\\_tl=en&x\\_tr\\_hl=en&x\\_tr\\_pto=wapp](https://www.contagioradio-com.translate.google.com/venom-una-de-las-costosas-armas-del-esmad/?x_tr_sl=auto&x_tr_tl=en&x_tr_hl=en&x_tr_pto=wapp).

435 See above n 420.

436 Information cited in S Torrado, “Venom, la cuestionada arma de los antidisturbios en Colombia”, El País, (21 May 2021), accessible at: <https://elpais.com/internacional/2021-05-21/venom-la-cuestionada-arma-de-los-antidisturbios-en-colombia.html>. See, also, report from Temblores, Indepaz and País Id, each cartridge is costed at 270,000 pesos, which is approximately similar to the account from El País, accounting for fluctuations in exchange rates.

## Regional and national standards and best practices

In addition to international law and legal standards, regional organisations such as the African Union (AU) and the IACHR, among others, each have binding human rights treaties and standards on the use of force and CCWs, which should be read alongside international law and standards. Africa and the Americas present some notable examples and are detailed below for illustrative purposes.

### Africa

In Africa, the right to life and related rights are detailed in the 1980 African Charter on Human and Peoples' Rights<sup>437</sup> (African Charter). The African Commission on Human and Peoples' Rights (African Commission), which is the organ of the AU responsible for monitoring the implementation of the African Charter, has issued a series of resolutions on the use of force and CCWs. In 2017, it also published Guidelines for the Policing of Assemblies by Law Enforcement Officials in Africa (African Commission Guidelines), a precursor to the UN Guidance on LLWs.<sup>438</sup>

Resolution 281 from 2014 on the right to peaceful demonstrations mandates states

to comply with the UN Code of Conduct and the UN Basic Principles, and expressly notes concerns with increasing levels of sexual violence against women protesters, including cases of rape and sexual assault during protests. It calls on states to refrain from the disproportionate use of force against protesters and to conduct impartial and independent investigations into all human rights violations to ensure that all perpetrators are held accountable.<sup>439</sup>

Resolution 375 from 2017 urges states to ensure that their “domestic laws on the use of force by law enforcement officials are in line with regional and international standards” and to provide law enforcement officials with “appropriate personal protective equipment and weapons less likely to cause an injury than firearms.”<sup>440</sup> Resolution 474, the most recent statement on the use of force which was issued in 2021 during the COVID-19 pandemic, reaffirms that law enforcement officials must comply with the principles of legality, necessity, proportionality, and accountability and must not endanger human life.<sup>441</sup>

In addition to these resolutions, the African Commission Guidelines provide clear guidance on the use of CCWs and note that “less lethal weapons, designed for the purposes of crowd control, may be abused

---

437 See above n 341 at articles 4, 9, 10 and 11.

438 African Commission on Human and Peoples' Rights, Guidelines for the Policing of Assemblies by Law Enforcement Officials in Africa, (2017), accessible at: <https://achpr.au.int/index.php/en/node/898>.

439 African Commission, 281 Resolution on the Right to Peaceful Demonstrations - ACHPR/Res.281(LV)2014, accessible at: [https://ecn1.org/sites/default/files/files/2021/ACHPRResolution181-2014\\_0.pdf](https://ecn1.org/sites/default/files/files/2021/ACHPRResolution181-2014_0.pdf).

440 African Commission, 375 Resolution on the Right to Life in Africa - ACHPR/Res.375(LX)2017, accessible at: <https://www.acdhrs.org/wp-content/uploads/2017/07/Resolution-on-the-Right-to-Life-in-Africa.pdf>.

441 African Commission, 474 Resolution on the Prohibition of Excessive Use of Force by Law Enforcement Officers in African States - ACHPR/Res. 474 (EXT.OS/ XXXI) 2021, <https://www.achpr.org/sessions/resolutions?id=505>.

by law enforcement officials who presume that such weapons are never lethal.”<sup>442</sup> The Guidelines further provide that:

[L]ess lethal crowd control weapons should only be used by well-trained law enforcement officials in order to prevent and minimise deaths, injuries and harm, and in a manner that complies with regional and international human rights standards. Prior to use, there must be in place precautionary measures such as appropriate independent testing of and training in the use of each type of device, in a range of situations, and in accordance with international standards.<sup>443</sup>

## Americas

In the Americas, the right to peaceful assembly is recognised in various treaties and other human rights instruments, including article 21 of the American Declaration of the Rights and Duties of Man<sup>444</sup> and article 15 of the American Convention on Human Rights.<sup>445</sup> Following these treaties, the IACHR and

the Inter-American Court of Human Rights have developed a series of standards—and jurisprudence—to protect the right of peaceful assembly. Both the IACHR and the Court have recognised that protest is linked to the promotion and defence of democracy<sup>446</sup> as a form of expression, participation, and a demand for the guarantee of political, economic, social, and cultural rights. Also, the IACHR’s Special Rapporteur for Freedom of Expression (FreeEx) has recognised that states have different obligations under the right to assembly: the obligations to respect, protect, and facilitate and the obligation to guarantee.<sup>447</sup>

Regarding the use of force and CCWs, a 2019 report by the IACHR’s Special Rapporteur for FreeEx notes that “the use of public force can be an important element in guaranteeing the right to protest and protecting the integrity of demonstrators. On the other hand, it also represents an important source of violations of these same rights.”<sup>448</sup> Therefore, the use of force must be exceptional and justified by satisfying the principles of legality, absolute necessity, and proportionality.<sup>449</sup>

The IACHR has also issued statements regarding the acquisition, use, and control

442 African Commission Guidelines above n 438 at 21.2.8.

443 *Id.*

444 See article XXI.

445 See article 15.

446 Inter-American Commission on Human Rights, Office of the Special Rapporteur for Freedom of Expression, “Protesta y Derechos Humanos: Estándares sobre los derechos involucrados en la protesta social y las obligaciones que deben guiar la respuesta estatal” (IACHR FreeEx report), (CIDH/RELE/INF, 22/19) at para 4 and Inter-American Court of Human Rights, *López Lone et al v Honduras* (5 October 2015) at para 148.

447 IACHR FreeEx report *id.* See, also, <https://www.oas.org/en/iachr/expression/publications/Protesta/ProtestHumanRights.pdf>.

448 IACHR FreeEx report *id.* at para 101.

449 *Id.* at paras 102-106.



of CCWs.<sup>450</sup> It considers the distinction between lethal and non-lethal weapons difficult to draw as “not only the design or characteristics of the weapon must be taken into account, but also other factors related to its use and control.”<sup>451</sup> It also warns of the indiscriminate effect of these weapons in the context of protests.

The IACHR has also called for the introduction and use of tests related to the acquisition and incorporation of new CCWs and types of ammunition.<sup>452</sup> These tests should be based on criteria provided by multidisciplinary and independent experts, should incorporate detailed regulations covering these weapons, and require specific training for officials in the appropriate use of each specific weapon. Finally, the IACHR notes that special attention should be paid to the development of new technologies in this area, such as remotecontrolled devices.

## Implementation of the law: experiences from the field

### Implementation of the law

While standards on the use of force and CCWs in protest contexts are expressed in international and regional law and standards and, in some cases, integrated into national regulations, our research indicates that there is a significant gap between these legal frameworks and their implementation on the ground by law enforcement officials.

Experts in all 18 countries studied for this report noted that there are international and regional instruments and constitutional, federal, state and local regulations which protect the right to life, and expression, assembly, and associative rights.<sup>453</sup> The experts cited the importance of these laws as the foundation for their advocacy and litigation work. At the same time, many interviewees reported frequent restrictions on the freedom of assembly in implementing the protections as they are written. In fact, the vagueness of applicable laws has, at times, been leveraged to strengthen policing powers. As one expert we interviewed noted:

**The general perception of CCWs, as non-lethal, has resulted in weaker or non-existent controls over their deployment.**

450 *Id* at para 120.

451 *Id* at para 121. Direct quotation from interviews with civil liberties experts conducted between October 2021 and March 2022.

452 From interviews with civil liberties experts conducted between October 2021 and March 2022.

453 See Section 1: Introduction for more information on the interview methods.

There is a long history of peaceful protest and critical social change thanks to protests but there has been repression at each stage. Many times, overbroad public order laws give a lot of discretion to the police (e.g., overly broad riot laws, street/nuisance laws, public order laws, orders about public spaces, and trespass laws). In some countries, the authorities introduce order laws to outlaw demonstrations, despite the existence of constitutional freedoms.<sup>454</sup>

According to many experts, the most common justifications for declaring protests “unlawful” include an alleged risk to public safety and the possibility of property damage or blocking traffic. The extent to which protests are prevented, therefore, depends largely on local authorities, by-laws, and city ordinances. As one expert noted, “[i]n many places, the landscape is ‘piecemeal’, making enforcement challenging.”<sup>455</sup> In general, there are “major issues with anti-riot bills. They are too broad as they can arrest people for just being in a group. Also, it doesn’t require violence but the threat of the violence, so it is very much a judgement call for police.”<sup>456</sup>

According to the experts interviewed for this report, the use of national security, anti-terrorism, or anti-hate speech laws has also been co-opted to restrict protest rights. An

interviewee noted that “over the past 4 to 6 years, there has been a shrinking of civic space. Over time, the challenge has been to ensure that good pieces of legislation are actually enacted. The card of national security is used to trump people’s rights.”<sup>457</sup> Another interviewee noted that “national security [is used] as an excuse over the right to freedom of expression, exacerbated by a history of terrorist attacks.”<sup>458</sup> Experts note that this is a fine needle to thread between hate speech, which may require certain limitations, and using hate speech laws as a pretext to curb free speech.

## Implementation of use of force guidelines

In addition to vague legal provisions and overbroad exceptions, a lack of transparency appears to be a barrier to implementing and relying on national use of force principles and guidelines. Most experts noted that while there are national or local use of force guidelines, these are often not publicly available and are either classified or inaccessible to the public: “the police manuals—when is a certain thing deployed, when are these weapons to be deployed, how to use them—all of that is obscured.”<sup>459</sup> In other cases, guidelines may exist, but police may be unfamiliar with them. As one interviewee stated, “there are some guidelines, service standing orders—how police should conduct themselves,

454 See above n 446.

455 *Id.*

456 *Id.*

457 *Id.*

458 *Id.*

459 *Id.*

talk to protesters—that are publicly available for anyone to read. . . but we doubt that all the police are reading all 1,000 pages or downloading it. [It] needs to be abridged.”<sup>460</sup> Operationalising those guidelines is another matter: “[g]overnment makes the guidelines but the police have to create its own definitions on how to operationalize those guidelines.”<sup>461</sup>

Most experts noted that working directly with law enforcement to ensure that protests are well organized and planned is a critical component of organising marches, demonstrations, and other large events. In many contexts, there are established and functional pathways for activists to be in full communication with law enforcement before, during and after protests to ensure the safety of all parties. In some cases, however, there are either dominant protocols requiring a permit for a protest or a notification system which in practice becomes a permission system. When permission is not granted, assemblies are declared illegal and the use of force to disperse them is justified by law enforcement. There are numerous other laws that can be used to limit protest rights. Public order laws such as curfews, transport regulations, and noise and nuisance rules can be used to neuter the right to protest.

Even where public order laws exist, the primary tactic used by police is much more basic: to disperse protesters and end the assembly altogether. “There is generally no de-escalation, the first instinct is to shut down.”<sup>462</sup> Police may actively disperse the

protest or may end it by “kettling”. In this method, protesters are blocked into a certain limited space and ordered to sit or stand, often for hours. They are not allowed to leave and are surrounded by police. Technically, police do not use violence during kettling, allowing them to evade use of force guidelines but interviewees noted that kettling is effectively “mass incarceration” for a short period of time.

### Experiences with the use of force

In many countries, the primary law enforcement response to protest is dispersal, including the use of force and arrest to intimidate protesters. In addition to being deployed to disperse assemblies, the use of force is deployed in response to other forms of conduct by protestors, such as refusing to disperse, chaining themselves to objects, damaging property, or wearing masks. But most often, the use of force is deployed for no reason at all. As one expert noted, “When is force used in protests? Basically, all the time.”<sup>463</sup>

In describing the use of force by law enforcement against protesters, the primary concern of most experts was the failure to issue warnings before weapons were deployed. Some interviewees noted:

- › “Police don’t always give a sufficient warning, especially if there has been an injunction, and [there is] not enough time between when the police issue a

460 *Id.*

461 *Id.*

462 *Id.*

463 *Id.*

dispersal warning and when they start beating people.”<sup>464</sup>

- › “Usually they will warn people but start repressing as people are trying to disperse and very quickly escalate to [the] use of LLWs.”<sup>465</sup>
- › There are even situations of “hunting protesters that were trying to run away.”<sup>466</sup>
- › [There is] no apparent relation between the actual threat to public order and level of force used.”<sup>467</sup>

## Police accountability for misuse of force

As detailed above, international law and standards define the state's obligation to report, investigate, and seek justice for any misuse of force. However, experts from all countries described a lack of accountability and noted that very few offending law enforcement officials have been convicted for misuse of force or injuring protesters. The general perception of CCWs, as non-lethal, has resulted in weaker or non-existent controls over their deployment. Officials are not convicted because accountability systems often lack transparency, allowing government officials to collude with offenders.<sup>468</sup> The lack of an independent judiciary was noted

by many interviewees to be a significant impediment to any real accountability.

The experts shared that internal accountability for police misuse of force, or for injuries caused, was not evident and, most often, non-existent. On occasion, once-existing independent oversight systems have been deliberately dismantled. Therefore, human rights organisations engage in lawsuits on behalf of survivors and victims to seek accountability through the local or national judicial system. However, the lack of judicial independence and lack of independent investigation of individual officers hampers litigation. Even when there is a successful lawsuit, punishment of the offenders or reparations for the victims are limited and take an excessive amount of time to materialise. Although judicial accountability is often limited, lawsuits can serve other purposes, including bearing witness, naming the crimes, informing the public, and making sure it is clear that someone is watching. As one interviewee noted, “[w]e remind the government of their obligations.”<sup>469</sup>

---

464 *Id.*

465 *Id.*

466 *Id.*

467 *Id.*

468 *Id.*

469 *Id.*

## Investigations of the misuse of force

When there are allegations of the misuse of force, investigations of those incidents are complicated and challenging. Research indicated that “[t]here is very little accountability in terms of police violence. There is very little transparency in terms of how and by what chain of command decisions are made.”<sup>470</sup> The corporate culture of law enforcement institutions was also mentioned as a barrier to achieving justice because “it is police investigating police. [There is] really no independent oversight.”<sup>471</sup>

Complex protocols for reporting police abuse, laws protecting law enforcement, corruption, a lack of independent accountability systems or judges, and a lack of evidence make accountability nearly impossible. There is also the difficulty of the “individualization of responsibilities” in the context of an assembly: it is difficult to name offending police officers because they are rarely identifiable by helmet numbers or identity badges. This is particularly problematic where law enforcement officials are either

masked with protective gear or have their faces covered. Some police officers also deliberately hide their name tags from view.

Evidence needed to investigate police use of force often comes from video recordings of the incidents, both by police and by activists. Regarding the use of police helmet-mounted or body-mounted video cameras for accountability purposes, most experts responded that cameras are typically used to document criminal activity by protestors but are not shared with the public when it is the law enforcement officers who have used force. “It is used to identify, arrest, intimidate, and prosecute protesters but it is not available to . . . civil society groups to highlight abuse or unlawful use of force by police.”<sup>472</sup> The use of mobile phone cameras by protesters and bystanders has become an increasingly effective method to document the management of assemblies, and the widespread availability of civilian-shot video on social media and news reports has the potential to improve police behaviour.

---

470 *Id.*

471 *Id.*

472 *Id.*



## Case study

## Deaths and severe injuries from police violence during protests against new criminal code

### Indonesia

Between 23 and 29 September 2019, students in many cities in Indonesia protested against new legislation that reduces the authority of the Corruption Eradication Commission (KPK), and against several bills, including a new criminal code that penalizes extramarital sex and defamation against the president. In Jakarta and other cities, protesters clashed with the police, resulting in many injuries and some deaths.

Among the numerous deaths documented in the context of these protests, on 26 September, two students died of gunshot wounds after a violent clash between the protesters and police in front of the provincial legislative council building in Kendari, Southeast Sulawesi.

Immawan Randy, a 21-year-old student from Halu Oleo University, died after being hit in the chest by a bullet fired by police. A fellow protester, Yusuf Kardawi, who was 19-years-old and a student from the same university, died after being shot in his head.<sup>473</sup> The police initially denied using live ammunition

or rubber bullets during the demonstration.<sup>474</sup> Eventually, the police declared that six policemen had carried firearms during the protest and, as a consequence, they were suspended. Initially, only disciplinary proceedings<sup>475</sup> were opened against the police officers, and light punishments were issued against them. Following widespread public protests over the lack of accountability, the authorities were obliged to initiate a criminal investigation. In the case of Immawan's death, the bullet fired at him matched the gun held by a policeman who was sentenced to four years in prison for the misuse of firearms. In Yusuf's death, the process is still ongoing due to numerous shortcomings in the investigation.

The police have claimed that they encountered several difficulties in the case's proceedings: no key witnesses, insufficient evidence, and no autopsy to establish Yusuf's cause of death. The family refused to allow an autopsy, as Yusuf had already been buried. The police used this refusal to justify the lack of a thorough investigation. Despite

473 LINE Indonesia, Pengumuman Terkait Penutupan LINE TODAY di Indonesia, accessible at <https://www.merdeka.com/teknologi/line-today-tutup-layanan-di-indonesia.html>.

474 IA Arbi, "One student dies, one in critical condition after protest turns violent in Kendari, Jakarta Post, (26 September 2019), accessible at: <https://www.thejakartapost.com/news/2019/09/26/one-student-dies-one-in-critical-condition-after-protest-turns-violent-in-kendari.html>.

475 Ikhwan Hastanto, "Police Officers Linked to Two Student Deaths in Indonesia Protests are Basically off the Hook," VICE, 31 October, 2019. <https://www.vice.com/en/article/3kxezv/police-officers-linked-to-two-student-deaths-in-indonesia-protests-are-basically-off-the-hook>



POLICE FIRED TEARGAS AND USED WATER CANNONS TO DISPERSE DEMONSTRATORS PROTESTING AGAINST GOVERNMENT REFORMS IN SEPTEMBER 2019. @FULLMOONFOLKS | TWITTER

the absence of an autopsy, some pieces of evidence, including a surveillance camera recording and the projectile itself, have been recovered and could be used to further the investigation.

Another student, Dicky Wahyudi, was gravely injured during the September 2019 protests. Dicky was struck by a police Barracuda armoured vehicle on 27 September while he was trying to escape the tear gas used to disperse protesters. The right side of his face was bruised and a wound was found on the right side of his chest. According to the South Sulawesi police chief, the massive armoured vehicle had accidentally crashed into Dicky. There is no further information about

the investigation by the police regarding this case.

These deaths add to the long ledger of impunity for police violence in the context of protests, a list that keeps growing due to unsolved cases and new ones that keep arising. The trend is clear: police use violence during protests and cause casualties, yet it is only low-ranking officers who are held accountable, to the extent there is any accountability at all. Typically, there is no chain of command accountability nor any evaluation as to how police should better manage and facilitate protests in the future.

# NEW AND REVISED RECOMMENDATIONS AND THE WAY FORWARD

PROTESTS IN PERU'S CAPITAL, LIMA, ON JANUARY 23, 2023 BY DEMONSTRATORS DEMANDING PRESIDENT DINA BOLUARTE'S RESIGNATION AND ELECTIONS. DURING THE POLICE INTERVENTION IN REACTION TO THE PROTEST, DEMONSTRATORS SUFFERED INJURIES AND RESPIRATORY DISTRESS DUE TO THE USE OF CHEMICAL AGENTS. KLEBHER VASQUEZ | AA

## Observations

The injuries inflicted by CCWs are as widespread as they are devastating. The use of KIPs, chemical irritants, water cannons, disorientation devices, acoustic weapons, and batons, among others, has produced a diverse array of negative health impacts which extend beyond the physical. Beyond individual injuries, the full toll of CCWs must include the psychological trauma they produce, the permanent disability they cause, the social cost of CCWs paid by targeted communities, and, significantly, the disproportionate impact CCWs have on certain vulnerable groups. The continued use and growing potency of CCWs since the publication of LiD1 in 2016 is particularly concerning. The potential use of inherently indiscriminate impact weapons that are new or were not emphasised in the last report, including multi-projectile KIPs, stun grenades

with shrapnel, and Venom, are cause for even more significant concern.

It is worth emphasising that the health effects described in this report may be exacerbated by factors that serve to impede access to medical care. These include CCW-related hazards to medical professionals, restricted access to medical transport, forbidding access to medical assistance at protests, direct attacks on medical professionals and street medics, and the chilling effect of detaining those injured by CCWs at medical facilities, which leads people not to seek necessary medical attention. These barriers to access to timely medical care play a significant role in increasing the risk of serious injury, permanent disability, or even death from CCWs.

Around the world, awareness of the use, dangers and harms of CCWs is increasing. The past six years have produced more—

and more rigorous–evidence documenting the severe health harms from CCWs used in crowd control. The proliferation of CCWs in all aspects of policing will result in a corresponding increase in death and injury, while novel mechanisms of injury will come to the fore as new CCW technologies are developed and refined. Without effective and immediate action, these avoidable harms will increase and intensify. Therefore, there is a pressing need for states to change their perceptions regarding the role of CCWs and adopt more stringent rules for their use. There is also an urgent need to engage in further research and empirical studies to develop clear scientific standards and parameters to regulate CCWs and their use and to further develop and clarify applicable international law and standards.

In this section, we outline recommendations with respect to pre-deployment, deployment, and post-deployment of CCWs in order to minimise the risk of these weapons for occasions when they are deployed. In addition, we make recommendations on international law and standards and detail challenges to the development and implementation of these standards at the national level. These recommendations are premised on several guiding principles that should be followed for the management of assemblies and for all uses of force and expand on the existing principles and recommendations detailed in LiD1. They are based on protecting health and limiting injuries, and ensuring the full exercise of free expression and assembly.

## Core principles

- › In the context of managing protests, the role of law enforcement officials is to protect the right to life and to facilitate assembly, association and free expression rights while ensuring public safety.
- › Given the duty of law enforcement to protect health and uphold rights, the most effective method to prevent violence in the context of protests is to engage in negotiations and dialogue with protesters and deploy associated de-escalation techniques.
- › The use of CCWs in protests should be an absolute last resort when dealing with genuine and imminent threats to safety, and only after all other means have been exhausted.
- › The mere fact that an assembly may be considered unlawful under domestic law does not justify dispersing the assembly or the use of CCWs.
- › Where there are people in the context of protests who either engage in or incite others to engage in acts of violence which require police intervention, the explicit goal of *any* intervention should be to de-escalate the situation and, where needed, focus on targeted interventions that do not infringe upon the rights of peaceful protesters.
- › If CCWs are deployed in the context of protests, their use should always be based on the principles of legality, precaution, necessity, proportionality, non-discrimination, and accountability, and the use of CCWs must be tested against the genuine threat faced and the legitimate aim pursued. Where any



of these principles *cannot* be satisfied, CCWs should not be deployed.

- › We note that the inherently indiscriminate nature of most CCWs renders highly unlikely their ability to meet the proportionality and necessity requirements for targeted policing interventions in the context of protest.
- › Weapons that are inherently indiscriminate are effectively dispersal agents used for forcibly terminating the entire assembly, and they restrict the ability of peaceful protesters to exercise their rights to free speech and assembly.
- › States must investigate any injuries or deaths related to the use of CCWs to ensure accountability and to better train and educate law enforcement officials on the lethal and harmful effects of CCWs.

## Patterns of risk

In addition to the core principles, certain patterns of risk in the use of CCWs in protests have emerged in our research.

- › *First*, the development of new CCWs and aggressive marketing by arms companies to law enforcement institutions is, in some cases, driving demand. Not all of these newer weapons are adequately tested, and some have been specifically developed for military purposes. The marketing, trade and use of such weapons in the absence of demonstrated data on

safety and effectiveness can lead to the unregulated proliferation of CCWs.

- › *Second*, the erroneous presumption that CCWs are non-lethal has several consequences: (1) that law enforcement and security personnel are not always trained in the proper use of such weapons; (2) that they are subject to fewer controls and regulations; (3) that they resort quickly to their use without trying other de-escalation techniques first or exhausting all other means before using CCWs; and (4) that the cases of injury and death from their use are then not properly investigated.
- › *Third*, some of the CCWs that are used in the management of protests are inherently inaccurate and indiscriminate in their effects, risking serious injury and death to the people targeted, other demonstrators, bystanders, and law enforcement officers themselves.
- › *Fourth*, the capacity of CCWs to achieve the goal of safe crowd dispersal is limited. The infliction of pain and incapacitation occasioned by CCWs is unlikely to result in the safe dispersal of protesters. On the contrary, the use of CCWs for crowd dispersal is often counterproductive, as they can cause confusion and panic, resulting in additional injuries as well as an escalation of violence.
- › *Fifth*, CCWs are intentionally misused as weapons for political repression rather than for legitimate crowd-control purposes.



## Recommendations

### Pre-deployment of CCWs

#### Design and trade

1. CCWs and/or policing equipment that can be used as a CCW, intended for use in the context of protests, must be designed and produced to ensure that they meet legitimate law enforcement objectives and comply with international law and standards. This duty applies to states and their agents as well as to companies that manufacture weapons for law enforcement as recognised in the UN Guiding Principles on Business and Human Rights.<sup>476</sup>
2. Weapons designed for military purposes are inappropriate for use in protests unless they have been adapted for crowd-control purposes and independently tested for appropriateness and effectiveness.
3. Weapons' design should not be altered or modified to produce lasting and painful effects as a means of punishment.
4. The redesign of chemical irritants to extend half-life, increase resistance to the weather, and prolong the effects of chemical agents must be halted; these practices violate the objectives of safe crowd management.
5. Public and private manufacturers of CCWs and related equipment should make publicly available an assessment of specific weapons risks to law enforcement institutions, their officials, and the public. States, law enforcement agencies, and manufacturers should make freely accessible the technical specifications of weapons in use.<sup>477</sup>
6. All safety data information and any other relevant information should be provided by manufacturers and should be made publicly accessible. Publicly available data should include each weapon's design features and parameters with a view to facilitating medical treatment and public knowledge of potential hazards. Manufacturers should also periodically publish updated medical studies regarding the safety of their weapons, along with the names of experts who have contributed to safety analyses, indicating the sources of funding or compensation.<sup>478</sup>
7. International, regional and national controls should be adopted on the trade in CCWs and equipment. These should prohibit the trade in inherently abusive weapons and equipment and control the trade in CCWs that are misused to

---

476 United Nations Office of the High Commissioner for Human Rights, Guiding Principles on Business and Human Rights: Implementing the United Nations 'Protect, Respect and Remedy' Framework, (2011), accessible at: [https://www.ohchr.org/documents/publications/guidingprinciplesbusinesshr\\_en.pdf](https://www.ohchr.org/documents/publications/guidingprinciplesbusinesshr_en.pdf) and UN Guidance on LLWs above n 6 at para 4.1.1.

477 UN Guidance on LLWs *id* at para 4.1.2.

478 *Id.*

ensure that they are not used in human rights abuses.

### Testing and legal review

8. Testing of new and existing CCWs should not rest solely in the hands of manufacturers. States should ensure that CCWs are subject to rigorous independent testing prior to making procurement decisions.<sup>479</sup> Testing, evaluation and approval should include a multidisciplinary approach that, in addition to law enforcement, includes technical specialists, academics, policymakers, health professionals, and civil society and consultation with communities that might be most impacted by the deployment of these weapons.
9. Testing of CCWs should consider legality, level of target accuracy and precision, risk of lethality, risk of severe injury or disability, level of pain inflicted, lifespan, reliability (i.e., minimal risk of malfunction), human factors that may affect their intended use, and any other relevant factors.
10. Testing to determine safe environmental parameters for the use of CCWs should occur in conditions that are similar to protest situations and under varied scenarios. The following factors, among others, should be considered: distance of engagement, urban or rural environment, expected weather conditions, nature of space (e.g.,

enclosed v open), possible collateral effects, and participant demographics.

11. The testing process should inform domestic regulations and guidelines for the lawful use of CCWs. The results from the testing should be made publicly available.
12. Newly acquired weapons should be subject to a pilot program to allow for evaluation and assessment.
13. A legal review should be conducted prior to procurement of a CCW, and it should be conducted to determine whether the procurement and use of a CCW would, in some or all circumstances, be prohibited by any rule of international or domestic law.<sup>480</sup> As part of the legal review, testing must—
  - 13.1. be conducted independently of the manufacturer and account for both the required and the potential capabilities and effects of the CCW;
  - 13.2. evaluate the effects of all reasonably, likely, or expected uses of the CCW;
  - 13.3. be based on impartial legal, technical, medical, and scientific expertise and evidence; and

479 General Comment No 37 above n 359 at para 81.

480 UN Guidance above n 6 at para 4.2.1.

- 13.4. consider the potential effects of use on individuals who may be especially vulnerable, including pregnant persons.<sup>481</sup>

### Selection and procurement

14. CCWs, and/or policing equipment that can be used as a CCW, whose “designated, expected, or intended use” does not comply with domestic and international law and standards, or which presents undue risk of loss of life or serious injury to anyone, including intended targets, bystanders, or law enforcement officials themselves, should not be authorised for procurement, deployment, or use.<sup>482</sup>
15. Where states and law enforcement institutions intend to procure or trade CCWs, details of the procurement and trade must be made publicly accessible *and* must be subject to a public participation process, including publicly accessible and independently verifiable human rights impact assessments on the specific CCWs in question. This includes transparent political oversight, approval, and accountability.
16. Prior to deployment, CCWs and ammunition should be clearly identified, inventoried, and stored to facilitate accountability in the post-deployment phase. When CCWs and ammunition are distributed, there should be a clear means of tracking distribution to individual law enforcement officials.

### Regulations, training and planning

17. Regulations, procedures, and/or protocols on the use of CCWs should be developed for law enforcement based on applicable domestic, regional and international laws. Human rights treaty obligations and international standards should be observed and operationalized in the protocols. These protocols should also reflect the findings from independent testing. Law enforcement should never rely solely on manufacturers’ instructions when defining protocols on acceptable use.
18. Regulations, procedures, and/or protocols on the use of CCWs should be publicly accessible and include details of—
- 18.1. when and how weapons may be used;
  - 18.2. training requirements;
  - 18.3. the risks associated with the use of these weapons, both individually and in crowd-control situations, including specific reference to vulnerable populations; and
  - 18.4. accountability measures.
19. Law enforcement officials should be trained in human rights standards, including the role of law enforcement in promoting and protecting the right to

481 *Id* at para 4.2.2.

482 *Id* at paras 4.2.3 and 6.3.2.

life, the rights to freedom of assembly and freedom of expression, the right to be free from violence and arbitrary arrest, the right to be free from torture and cruel, inhuman, and degrading treatment and punishment, and due process rights.

20. Law enforcement should be trained in the human rights-compliant use of CCWs. In addition to teaching the technical aspects of the weapon and its use, training should be contextual, including addressing the specific aspects and challenges of managing protests.
21. Training should be continuous and ongoing and should include simulations and exercises that review past cases to identify inappropriate or unlawful weapon use and consider alternative approaches.
22. Training must include information about the medical and health effects and risks of using particular CCWs, and precautions that should be taken in using particular weapons.
23. Training of projectile weapons should mirror that of formal firearms training, with emphasis placed on the recognition of unsafe firing conditions. Training should include the determination of safe firing distances, given the importance of distance in attenuating the effects of impact projectiles.
24. With chemical irritants, training must include a discussion of concentration levels and an understanding that the effects of the weapons vary depending on, among others, environmental conditions, the density of the crowd, duration of exposure, pre-existing medical conditions, and the vulnerability of specific populations.
25. Law enforcement officials who have not received the appropriate training (as described above) should not be permitted to carry or use CCWs.
26. Pre-deployment planning should always consider contextual factors, including the nature of the area where the protest is occurring, whether the protest is static or mobile, the weather conditions, access to exits, and the size and demographics of the crowd, among other factors.
27. Pre-deployment planning should also have clearly designated command roles and authorities. Authorization should come from a senior-level officer on the scene, who is able to assess the conditions where CCWs may be used and is responsible for the manner and scope of their deployment.

### Use of force and deployment of CCWs

28. The use of any kind of force, including CCWs, must always comply with the principles of necessity, proportionality, legality, precaution, non-discrimination, and accountability.<sup>483</sup>

---

483 General Comment No 37 above n 359 at para 78.

29. Law enforcement officials must always aim to avoid the use of force and use non-violent tactics wherever possible.<sup>484</sup> In exceptional circumstances and where there is an imminent and actual threat, law enforcement officials may only use the minimum force necessary to address the threat and, if possible, should take all reasonable measures to engage in de-escalation techniques.<sup>485</sup>
30. Appropriate de-escalation techniques should be used to minimise the risk of violence. Law enforcement officials should be aware that even the display of CCWs may escalate tensions and increase the potential for violent conflict during protests. Where force is proportionate and is necessary to achieve a legitimate law enforcement objective, all possible precautionary steps must be taken to avoid, or at least minimise, the risk of injury or death.<sup>486</sup>
31. When a decision is made to use force in response to acts of violence, law enforcement officials should not treat crowds as a single violent entity because of the actions of some individuals. Law enforcement officials must make every effort to identify and isolate violent individuals without unnecessarily interfering with the rights of other protesters.<sup>487</sup> If it is decided that CCWs are an appropriate means of stopping individual acts of violence, the final decision to use CCWs must account for the likely proximity of third parties and bystanders.<sup>488</sup>
32. Law enforcement officials should avoid the use of CCWs towards those who are particularly vulnerable to the harmful consequences of the use of force in general and to the effects of specific CCWs, including children, pregnant persons, older persons, persons with disabilities, and persons with mental health conditions and impairments.<sup>489</sup>
33. Law enforcement officials must use proportional means to effect an arrest in the context of a protest when individuals are passively resisting. In such circumstances, law enforcement officials should only use targeted interventions and the minimum force necessary and must avoid resorting to any force that carries the risk of serious injury.
34. CCWs should not be used without first clear verbally warning protesters and giving them adequate and appropriate opportunity to comply with a lawful order to exit and/or find safe shelter.

---

484 UN Guidance on LLWs above n 6 at para 2.2.

485 General Comment No 37 above n 353 at para 78.

486 UN Guidance on LLWs above above n 359 at para 6.3.1.

487 *Id* at para 6.3.2.

488 *Id*.

489 *Id* at para 2.7.



A safe route to disperse must be guaranteed.<sup>490</sup> CCWs with wide-area effects, such as tear gas and water cannons, have indiscriminate effects. When such weapons are used, law enforcement officials are responsible for mitigating the risk of injury through stampedes or “crowd crushes”.<sup>491</sup>

## The use of firearms and live ammunition

35. The use of firearms and live and/or lethal ammunition should be entirely prohibited in the context of managing crowds and facilitating protests.

### Kinetic impact projectiles

36. Kinetic impact projectiles (KIPs) can cause serious injuries, permanent disability, and death. Severe injuries are more likely when KIPs are fired at close range. When launched from afar, these weapons are often inaccurate and can strike vulnerable body parts or bystanders. Therefore, the medical evidence in this report underscores that KIPs should never be fired indiscriminately into groups and are, in general, an inappropriate weapon in any protest context.

37. KIPs must be expressly prohibited for the sole purpose of crowd dispersal; they cannot be used effectively and

safely in groups of people. KIPs must never be fired at close range and should never be targeted at the head or other vital areas of the body, where impact typically causes serious injury and, in some instances, death.

38. Any KIP that fires multiple projectiles is inherently indiscriminate<sup>492</sup> and must be prohibited in the context of protests. It is not possible to deploy these weapons safely against crowds or individuals.

39. Pellet rounds, which fire multiple projectiles that follow uncontrollable trajectories, are both indiscriminate and dangerous. Their frequently small size and high velocity render them exceptionally hazardous. As a result, pellet rounds (birdshot, buckshot, and multiple projectile munitions) must be expressly prohibited in all protest settings; metallic pellets may never be categorised as a CCW.

40. KIPs that have a metal component as part of their composition, especially those with metal cores, are not safe for crowd management and should be expressly prohibited. These weapons, including rubber-coated metal rounds, lead pellets, small calibre rifle or pistol rounds, and bean bag rounds, impact targets with excessive energy and high velocities and have a very high potential to cause serious injury and death.<sup>493</sup>

490 *Id* at para 6.3.3.

491 General Comment No 37 above n 359 at para 87.

492 UN Guidance on LLWs above n 6 at para 6.3.2.

493 *Id*.

## Chemical irritants

41. Chemical irritants, when deployed using canisters or grenades, are inherently indiscriminate by nature, cause severe pain and injuries and frequently escalate tensions. Therefore, extreme caution must be used before and during deployment that considers the presence of bystanders and the existence of areas of egress and airflow to minimise any risk of overexposure due to the serious risk of injury.
42. Chemical irritants that should be expressly prohibited in the context of protests due to the risk of death and serious injury include:
  - 42.1. Launchers that fire multiple chemical irritant canisters, such as the Venom system.
  - 42.2. “Barrier-penetrating,” “barrier-blind,” “barricade,” tear gas rounds, or any round designed to defeat physical barriers or that are excessively dense or considered “military grade”.
  - 42.3. Chemical irritants with components that are determined to be hazardous or in quantities, proportions, concentrations, or admixtures that may be considered toxic.
  - 42.4. Chemical irritants that have passed their expiration date or are otherwise in disrepair.
43. Specific methods and patterns of chemical irritant deployment are associated with an elevated risk of serious injury or death. Use of chemical irritants in the following circumstances constitutes reckless and dangerous use of these weapons and must be prohibited:
  - 43.1. In confined spaces or in spaces where a crowd cannot safely disperse (including sports stadiums, prisons, and other high-density enclosed spaces with limited egress capacity) - this significantly increases the risk of death or serious injury from crowd crush and stampedes.<sup>494</sup>
  - 43.2. Firing chemical irritant canisters or throwing grenades directly at individuals or groups, particularly when they strike the head or sensitive body parts, as they can result in blunt trauma, burns and severe or permanent disability and death.
  - 43.3. Exposing children, older persons or other vulnerable groups to chemical irritants indiscriminately.
  - 43.4. In situations of purely passive resistance. (In accordance with the principle of necessity, once a person is already under the control of a law enforcement

---

494 *Id* at para 7.2.7.

official, no use of a chemical irritant will be lawful.)

- 43.5. Repeated or prolonged exposure for demonstrators or for residents who may be exposed in their homes, workplaces, and communities.
- 43.6. After exposure, restraining a suspect by placing them in the prone position (i.e., where the person is lying flat with the chest down and back up). If an individual suffering from the effects of a chemical irritant is restrained, his or her breathing must be monitored constantly. Any unexpected or long-lasting effects should be referred for medical assessment and treatment.”<sup>495</sup>

### Water cannons

44. The use of water cannons against individuals at short ranges should be prohibited, owing to the risk of injury from the water jet itself or from injuries due to slips, trips, and falls secondary to the impact of a water cannon.<sup>496</sup>
45. The decision to deploy water cannons must consider potential environmental hazards that may heighten the risk of injury resulting from their use. Water cannons should not be used against

persons in elevated positions or in any situation wherein the force of the water jet can push targets into dangerous objects. Water cannons should not be used in cold weather due to the risks of hypothermia and cold-water shock.<sup>497</sup>

46. Water cannons should never be used against restrained persons or persons otherwise unable to move or escape a specific situation.<sup>498</sup>
47. Alterations to the properties of water designed to provoke pain, such as heating or the addition of chemical irritants, must be prohibited.
48. Other water cannon additives—such as chemicals that emit foul odours or coloured dye—must be prohibited. The primary purpose of these weapons appears to be excessive or collective punishment and humiliation, which are unlawful and do not constitute legitimate policing tactics.

### Disorientation devices

49. Disorientation devices can cause significant injuries, and they are difficult to deploy in a manner that ensures only isolated targets are affected without the risk of injury to bystanders. As a result, these indiscriminate weapons (including stun grenades, flash bangs and other disorientation devices)

495 *Id* at para 7.2.4.

496 *Id* at para 7.7.4.

497 *Id* at para 7.7.3

498 *Id* at para 7.7.4.

should not be used in protest contexts or crowd settings.

50. Explosive stun grenades that have been engineered to fragment or disperse projectiles behave similarly to multiple projectile KIPs in that the user cannot control the trajectory of each fragment to ensure bystanders or vital parts of the body are not affected. As a result, they are inherently indiscriminate and have no legitimate law enforcement role.

### Acoustic weapons

51. The use of acoustic weapons or signalling devices at any distance and exposure time at which the decibel output is likely to cause permanent threshold shift (permanent hearing damage) should be prohibited.<sup>499</sup>
52. The use of acoustic weapons or hailing devices to dissuade or deter individuals should only be limited to cases in which it is unlikely other individuals may be subject to the potentially hazardous effects of focused sound.
53. Acoustic weapons may cause hearing damage if thresholds of sound intensity and duration are exceeded. These thresholds may vary from weapon to weapon. Accordingly, rigorous testing should be conducted to identify

prudent maximum sound intensities, determine minimum distances of use, and establish limits on the duration of continuous operation.

### Blunt force weapons

54. Batons should only be used in exceptional circumstances and only against violent individuals posing significant risks to themselves or others:<sup>500</sup>
- 54.1. Batons should never be used against a person who is neither engaged in or threatening violent behaviour; such use is likely to amount to cruel, inhuman, or degrading treatment or torture.<sup>501</sup>
- 54.2. Batons should never be used against persons in restraints or persons otherwise unable to move or escape a specific situation.<sup>502</sup>
55. Batons should not be used to cause considerable injury and excessive pain, such as strikes to the knees, elbows, wrists, and groin areas:<sup>503</sup>
- 55.1. Jabs or driving strikes with a baton at the thorax, neck or head should be avoided

---

499 *Id* at para 7.8.5.

500 *Id* at 7.1.3.

501 *Id*.

502 *Id* at para 7.7.4.

503 See Amnesty International, "Blunt force: Investigating the misuse of police batons and related equipment, accessible at: <https://www.amnesty.org/en/latest/research/2021/09/blunt-force/>.

because of the risk of injury to and damage to vital organs.<sup>504</sup>

55.2. Batons should never be used in neck or choke holds.<sup>505</sup>

56. Some blunt force weapons, such as whips, direct contact electric shock weapons and weighted or spiked batons, have no legitimate law enforcement role that cannot be fulfilled through less harmful means. Their use by law enforcement should be prohibited.

### New frontiers

57. New technologies being developed for crowd control should aim to be less prejudicial and less dangerous to the physical integrity of people. These new technologies should be tested for compliance with human rights standards and existing guidelines before procurement and use. They should also be tested to ensure their use complies with the principles of necessity, proportionality, legality, and accountability.

58. Recommendations on new or envisaged weapons are based on precaution and existing operational data:

58.1. As the use of armed drones has a risk of causing significant head injuries, a moratorium on the use of remotely operated armed drones in protest

contexts should be issued until further evidence on the impacts of armed drones in protest contexts has been collected and their lawful use has been established.

58.2. Fully autonomous weapons systems must never be used by law enforcement during a protest.<sup>506</sup>

58.3. Direct contact electric shock weapons—such as stun guns and stun shields, for example, as well as projectile electric shock weapons in a direct contact mode—are designed to cause compliance through pain and deliver an electric shock through contact between the weapon and the target individual. These weapons carry an unacceptable risk of arbitrary force, and their use fulfils no legitimate law enforcement purpose that cannot be achieved through less harmful means. As such, the use of direct contact electric shock weapons by law enforcement should be prohibited.

58.4. Because directed energy devices (DEDs) are not commonly used in law enforcement, and there is no

504 UN Guidance on LLWs above n 6 at paras 7.1.4 and 7.1.5.

505 *Id* at para 7.1.5.

506 General Comment No 37 above n 359 at para 95.



sufficient understanding of their safety in crowd control settings, such weapons should not be used for crowd management. There are serious concerns about prolonged exposure, the risk of cellular damage and high-degree burns, and the potential for abuse. If these concerns are confirmed, the development and sale of these weapons for law enforcement purposes and especially for crowd control must be halted, as the use of these weapons will be disproportionate by design.

## Post-deployment of CCWs and medical assistance

### Medical assistance

59. Law enforcement must ensure that proper medical assistance is available to protesters and provide prompt access to aid when CCWs are deployed. Identities of those seeking care should not be released to law enforcement officials.
60. Medical care for the sick and wounded must not be restricted or interfered with. Medical workers should never be targeted, blocked, attacked, arrested or interfered with for fulfilling their obligations.
61. Medical objects, such as ambulances and clinics, should not be used for any law enforcement purposes.

### Accountability

62. Law enforcement officials should record and report any use of CCWs, including specific models of CCWs deployed, the distances from the targeted individuals/bystanders and the duration of deployment, the number of each type of CCW used, and the specific of any injuries caused by CCWs. Review of this reporting must confirm that the reporting is accurate, and that the use of CCWs was proportionate, necessary, and lawful.
63. Law enforcement officials should wear visible identification whenever CCWs are used, in order to facilitate accountability.
64. There should be a clear chain of command, responsibility, and accountability. All decisions taken should be traceable, and those who have taken the decisions must be held accountable for them.
65. All deaths, injuries and suspected misuses of CCWs should be thoroughly investigated by a body independent of the implicated officials, with a view to establishing responsibilities and accountability of the officials involved, including the various levels of the command structure in charge during the incident. Where there is evidence of unlawful conduct, commanders and responsible officers should face administrative disciplinary measures and/or criminal prosecution, as appropriate.

66. Police officers under investigation for the misuse of CCWs or for any other abuse of force should be removed from active frontline duty or suspended until their case is resolved.
67. Legal provisions should ensure that victims can obtain redress, even in the absence of a criminal conviction of the perpetrator(s), as well as fair and adequate compensation, including the means for the fullest rehabilitation possible.

## Next steps

Since INCLO and PHR started researching CCWs, progress has been made at the international, regional and national levels. There has been substantive progress since the approval of the UN Basic Principles and, more recently, General Comment No 37 and the UN Guidance on LLWs, both issued in 2020, have shown notable advances in standard setting regarding the regulation of CCWs and outlining specific recommendations. There has also been increased media coverage of protests worldwide and more nuance in the coverage that speaks of the use of “less-lethal” as opposed to “non-lethal” weapons, an important conceptual distinction. Most importantly, we have seen law reform in different jurisdictions aiming to regulate the use of CCWs.<sup>507</sup>

However, further development is needed. There is a pressing need for the introduction of these standards into domestic legal frameworks and police protocols. International and regional organisations have a role in promoting these tools and advising states on operational ways of strengthening their protections. However, in addition to the implementation and proper application of international laws and standards, other changes are necessary. Around the world, national-level laws, policing practices, police culture, transparency, and accountability measures often fall short of international standards. This gap risks rendering international law and standards as toothless “paper rights” overridden by more restrictive national and local laws. Much more must be done to bring national and local laws in line with more progressive international laws and standards.

We hope that the recommendations in this report can inform processes at the UN and other regional fora to adopt stronger and more evidence-based standards on the use of CCWs. Additionally, General Comment No 37 and the UN Guidance on LLWs, both issued early in the global COVID-19 pandemic, have not been properly promoted to States. It is of utmost importance that these standards reach law enforcement and security institutions and that their provisions are adopted and operationalized by internal

---

507 In Canada, a motion was presented at the City Council to withdraw tear gas from the SPVM (Service de Police de la Ville de Montréal) arsenal, which was supported by a coalition of 30 organizations. The final motion adopted by the City Council on 15 December 2020, asked the Public Health authority to provide an opinion as to the effect exposure to tear gas has on health and instructed Montreal’s Public Security Commission to consider that finding as well as to examine the impact of tear gas on civil liberties. In Chile, in September 2020, a bill to modify the law on Arms Control (Law N° 17.798) was introduced in the House Chamber to regulate the use of CCWs. The bill did not pass, but the precedent is significant. See <https://www.diarioconstitucional.cl/wp-content/uploads/5010/2024/1597418972.pdf>. In the US, a 2020 document (from the Safe Coalition, North Carolina) calls on Charlotte City Council to build upon the protections stated in the 2015 Civil Liberties Resolution including analysis and recommendations regarding the proper use of CCWs. See: <https://charlottenc.gov/CityCouncil/Committees/Safe%20Communities/Sept%2015%202020%20Safe%20Communities%20meeting%20materials.pdf>.

protocols. We also want to see regional fora adopt regional standards on these issues, in line with the UN. Lastly, more research on and testing of these weapons is needed. This testing should inform processes to develop more standards, especially around new technologies and trade.

Below we outline specific calls:

## United Nations

1. The Office of the High Commissioner for Human Rights and/or the Special Rapporteur on Freedom of Assembly and of Association should be directed to prepare reports on:
    - 1.1. The health consequences of the use of CCWs.
    - 1.2. The current domestic regulatory regimes applicable to CCWs in States Parties, including the preparation of a draft model law on the pre-deployment, deployment, and post-deployment of CCWs in policing contexts.
    - 1.3. The application of the UN Guiding Principles on Business and Human Rights<sup>508</sup> to manufacturers of CCWs.
  2. The UN Guidance on LLWs must be reviewed in 2025, and civil society should be invited to participate in that process.
  3. During the next review of the UN Guidance on LLWs,<sup>509</sup> the group of experts should:
    - 3.1. Detail which weapons are expressly prohibited in protest contexts.
    - 3.2. Provide detailed guidance on the lawful use of drones in the context of protests and highlight instances in which the use of drones is unlawful.
    - 3.3. Provide detailed guidance on the lawful use of autonomous weapons systems, including if their deployment can ever be lawful, and highlight instances in which the use of autonomous systems is unlawful.
  4. States should engage with and support international- and regional-level processes to develop trade controls, including the UN process towards a Torture-Free Trade Treaty.<sup>510</sup>
1. The UN Human Rights Committee should direct States Parties to report on current domestic regulatory regimes

508 See above n 476.

509 UN Guidance on LLWs above n 6 at para 8.1.

510 See <https://storymaps.arcgis.com/stories/2d9b2865e511428aa6b74cce84e984c5>.

## African Commission on Human and Peoples' Rights

1. The African Commission should conduct a review of domestic regulations, protocols, and standing orders in States Parties which pertain to the trade<sup>511</sup> and use of CCWs and prepare a report on the compliance of State Parties' regulations, protocols, and standing orders with international law and standards.
2. The African Commission should create a working group to investigate and report on the misuse of CCWs in Africa and to suggest appropriate revisions to the 2017 Guidelines for the Policing of Assemblies by Law Enforcement Officials in Africa.

## Inter-American Commission on Human Rights

1. The IACHR should conduct a review of domestic regulations, protocols, and standing orders in States Parties which pertain to the use of CCWs. Particular attention should be paid to the policing practices in the management of assemblies, dispersal techniques, and the recent cases of misuse of CCWs, particularly in relation to the hundreds of eye injuries produced by KIPs.
2. The IACHR should promote further controls on the manufacture and trade of CCWs in the region. For example, it should issue a resolution with the view to prohibiting and preventing the use, production, export, and trade of equipment designed to inflict torture or ill-treatment and the abuse of any other equipment or substance to these ends in accordance with ongoing processes at the UN and other regional mechanisms<sup>512</sup>.

---

511 See African Commission, 472 Resolution on the prohibition of the use, production, export and trade of tools used for torture. ACHPR/Res.472 (LXVII) 2020, accessible at: <https://www.achpr.org/sessions/resolutions?id=497>.

512 *Id.*

## Final remarks

Achieving the proper use of CCWs is a complex task that can only be achieved by multiple actors: from political and governmental authorities and law enforcement and security institutions to international and regional organisations, academia, healthcare experts and civil society. Of utmost importance is engaging the medical community on this issue: they are able to document injuries, not only to improve their treatment but also to be able to properly investigate the misuse and abuse of CCWs and enable accountability for abuses and wrongdoings, which is key to preventing these violations. The proper use of CCWs is fundamental to ensure the protection and facilitation of the exercise of the right to protest. Law enforcement and security institutions have a role to play in this facilitation. This report's contribution is to inform this role and appropriate intervention to enable the lawful and harm-free management of assemblies.



## USEFUL RESOURCES

### Executive summary

United Nations Office of the High Commissioner for Human Rights, United Nations Human Rights Guidance on Less-Lethal Weapons in Law Enforcement, 2020, accessible at: [https://www.ohchr.org/Documents/HRBodies/CCPR/LLW\\_Guidance.pdf](https://www.ohchr.org/Documents/HRBodies/CCPR/LLW_Guidance.pdf).

### Section 1: Introduction

Haar RJ *et al.*, "Health impacts of chemical irritants used for crowd control: a systematic review of the injuries and deaths caused by tear gas and pepper spray," *BMC Public Health* 17, no 1b (October 2017): 831, doi:10.1186/s12889-017-4814-6.

Haar RJ *et al.*, "Death, injury and disability from kinetic impact projectiles in crowd-control settings: a systematic review," *BMJ Open* 7 (2017): e018154, doi:10.1136/bmjopen-2017-018154.

INCLO, *Protesting during a pandemic: State responses during COVID-19*, April 2021, accessible at: <https://files.inclo.net/content/pdf/55/Protest-and-State-Response-V7.pdf>.

Moher D, Liberati A, Tetzlaff J and Altman DG, *PRISMA Group Preferred Reporting Items for Systematic Reviews and Meta-analyses: The PRISMA statement*, *PLoS Med.* 2009;6:e1000097. doi: 10.1371/journal.pmed.1000097.

Ortiz I *et al.*, "An Analysis of World Protests 2006-2020," in *World Protests* (2022), pp 13-81, Palgrave Macmillan, Cham, doi:10.1007/978-3-030-88513-7.

United Nations Congress on the Prevention of Crime and the Treatment of Offenders, *Basic Principles on the Use of Force and Firearms by Law Enforcement Officials*, 1990, accessible at: <http://www.ohchr.org/Documents/ProfessionalInterest/firearms.pdf>.

### Section 2: Crowd-control weapons and their impacts

Banayot, Riyad. "Open-globe injuries in Palestine: epidemiology and factors associated with profound visual loss at St. John Eye Hospital, Jerusalem Riyad Banayot St. John Eye Hospital, Jerusalem, Palestine." *Ophthalmology Journal* 6 (2021): 165-170.

Beatty, Jennifer A., *et al.* "Injury patterns of less lethal kinetic impact projectiles used by law enforcement officers." *Journal of forensic and legal medicine* 69 (2020): e101892-e101892.

Bhat, Towseef A., et al. "Musculoskeletal pellet gun injuries; report from a conflict zone." *International Journal of Research in Orthopaedics* 3.5 (2017): 944-950.

Chauvin, Aurore, et al. "Ocular injuries caused by less-lethal weapons in France." *The Lancet* 394.10209 (2019): 1616-1617.

Darwazeh, Rami, et al. "Traumatic brain injury caused by missile wounds in the north of Palestine: a single Institution's experience with 520 consecutive civilian patients." *World Neurosurgery* 116 (2018): e329-e339.

El Zahran, Tharwat, et al. "Riot-related injuries managed at a hospital in Beirut, Lebanon." *The American Journal of Emergency Medicine* 42 (2021): 55-59.

Kaske, Erika A., et al. "Injuries from less-lethal weapons during the George Floyd protests in Minneapolis." *New England journal of medicine* 384.8 (2021): 774-775.

Mala, Tariq Ahmed, Syeed Rayees Ahmad, and Shahid Amin Malla. "Management and pattern of pellet gun injuries in war conflicted Kashmir Valley, India." (2019).

Natarajan, Sundaram, and Mohd anash Pathan. "Impact of 777 Pellet Gun Ocular Injuries in Kashmir." *Investigative Ophthalmology & Visual Science* 59.9 (2018): 4427-4427.

Obeng, Francis Kwasi, et al. "Management of Ocular Pellet Injury." *Specialty Journal of Medical Research and Health Science* 2.4 (2017): 24-34.

Olson, Kristofor A., et al. "Penetrating injuries from "less lethal" beanbag munitions." *New England journal of medicine* 383.11 (2020): 1081-1083.

Papy, Alexandre, et al. "Police Use of Non-lethal Weapons: Analysis of Real Cases." *Human Factors and Mechanical Engineering for Defense and Safety* 3.1 (2019): 1-10.

Pearl, Rachel C., Sam Torbati, and Joel M. Geiderman. "Kinetic Projectile Injuries Treated During Civil Protests in Los Angeles: A Case Series." *Clinical Practice and Cases in Emergency Medicine* 5.4 (2021): 385.

Rafiq, Suhail, et al. "How lethal is a pellet gun for eyes?" *The Pan-American Journal of Ophthalmology* 2.1 (2020): 5.

Rafiq, Suhail, et al. "Lung Injuries on Computerized Tomography Due to Pellet Gun." *Galician medical journal* 26.2 (2019).

Rodríguez, Álvaro, et al. "Ocular trauma by kinetic impact projectiles during civil unrest in Chile." *Eye* 35.6 (2021): 1666-1672.

Shah, Faisal Qayoom, Jasmine Asif, and Tariq Qureshi Syed. "Perforating ocular trauma due to shotgun pellet- Clinical profile and visual outcome." *Indian Journal of Ophthalmology* 69.5 (2021): 1224.

Shah, Faisal Qayoom, Syed Tariq Qureshi, and Arshi Nazir. "Visual outcome of closed globe injury due to shotgun pellet." *Indian Journal of Medicine and Healthcare* 6.7 (2019): 1-8.

Tabish, S. A., et al. "Characteristics, Outcomes, and Implications for Care of Firearm Injuries During Unrest in a Conflict Zone of India: A Clinical Retrospective Study." *J Trauma Treat* 7.434 (2018): 2167-1222.

## Section 3: Laws and standards on the use of force and crowd-control weapons

African Charter on Human and Peoples' Rights, (27 June 1981), accessible at <https://www.achpr.org/legalinstruments/detail?id=49>.

African Commission on Human and Peoples' Rights, Guidelines for the Policing of Assemblies by Law Enforcement Officials in Africa, (2017), accessible at: [https://www.achpr.org/public/Document/file/Any/achpr\\_guidelines\\_on\\_policing\\_assemblies\\_eng\\_fre\\_por\\_ara.pdf](https://www.achpr.org/public/Document/file/Any/achpr_guidelines_on_policing_assemblies_eng_fre_por_ara.pdf).

African Commission, 281 Resolution on the Right to Peaceful Demonstrations - ACHPR/Res.281(LV)2014, accessible at: <https://www.achpr.org/sessions/resolutions?id=328>.

African Commission, 375 Resolution on the Right to Life in Africa - ACHPR/Res.375(LX)2017, accessible at: <https://www.achpr.org/sessions/resolutions?id=418>.

African Commission, 474 Resolution on the Prohibition of Excessive Use of Force by Law Enforcement Officers in African States - ACHPR/Res. 474 (EXT.OS/ XXXI) 2021, accessible at: <https://www.achpr.org/sessions/resolutions?id=505>.

*Brake v City of Fort Wayne*, Case No. 1:20-cv-00345 (2 October 2022), accessible at: [https://www.aclu-in.org/sites/default/files/field\\_documents/brake\\_v\\_ftwayne\\_-\\_complaint.pdf](https://www.aclu-in.org/sites/default/files/field_documents/brake_v_ftwayne_-_complaint.pdf).

Centre for Human Rights, University of Pretoria, Overview of Global and Regional Human Rights Standards on the Police Use of Force, (20 May 2020), accessible at: [https://www.up.ac.za/faculty-of-law/news/post\\_2896772-overview-of-global-and-regional-human-rights-standards-on-the-police-use-of-force](https://www.up.ac.za/faculty-of-law/news/post_2896772-overview-of-global-and-regional-human-rights-standards-on-the-police-use-of-force).

Convention Against Torture and Other Cruel, Inhuman and Degrading Treatment or Punishment; (10 December 1984), accessible at: <https://www.ohchr.org/en/professionalinterest/pages/cat.aspx>.

Convention on the Prohibition of the Development, Production, Stockpiling and Use of Chemical Weapons and on their Destruction, (3 September 1992), accessible at: <https://legal.un.org/avl/ha/cpdpsucw/cpdpsucw.html>.

*Driscoll v City of Denver*, Case No. 1:21-cv-02866 (25 October 2021), accessible at: <https://kdvr.com/wp-content/uploads/sites/11/2021/10/Driscoll-Complaint-2.pdf>.

General Comment No 36 (2018) on article 6 of the International Covenant on Civil and Political Rights, on the right to life, adopted by the Human Rights Committee (General Comment No 36), accessible at: [https://tbinternet.ohchr.org/Treaties/CCPR/Shared%20Documents/1\\_Global/CCPR\\_C\\_GC\\_36\\_8785\\_E.pdf](https://tbinternet.ohchr.org/Treaties/CCPR/Shared%20Documents/1_Global/CCPR_C_GC_36_8785_E.pdf).

General Comment No 37 (2020) on the right of peaceful assembly (article 21), adopted by the Human Rights Committee (General Comment No 37), accessible at: <https://daccess-ods.un.org/access.nsf/Get?OpenAgent&DS=CCPR/C/GC/37&Lang=E>.

Geneva Academy, United Nations Human Rights Guidance on Less-Lethal Weapons, accessible at: <https://www.adh-geneve.ch/research/publications/detail/500-united-nations-human-rights-guidance-on-less-lethal-weapons-in-law-enforcement>.

*Goyette v City of Minneapolis*, 20-CV-1302 (WMW/DTS), 2022 WL 370161 (D. Minn. Feb. 8, 2022), accessible at: <https://www.aclu-mn.org/en/press-releases/goyettesettlement>.

Inter-American Court of Human Rights, *López Lone et al v Honduras* (5 October 2015).

Inter-American Commission on Human Rights, Office of the Special Rapporteur for Freedom of Expression, “Protesta y Derechos Humanos: Estándares sobre los derechos involucrados en la protesta social y las obligaciones que deben guiar la respuesta estatal”, (CIDH/RELE/INF, 22/19).

International Covenant on Civil and Political Rights, (16 December 1966), accessible at: <https://www.ohchr.org/en/professionalinterest/pages/ccpr.aspx>.

*Martinez v City of Santa Rosa*, 2020 WL 9762698 (N.D.Cal.) (23 June 2020), accessible at: <https://turtletalk.files.wordpress.com/2020/06/1-complaint-8.pdf>.

Omega Research Foundation, “Tools of torture and repression in South America: Use, manufacture and trade”, (2016), accessible at: <https://omegaresearchfoundation.org/publications/tools-torture-and-repression-south-america-use-manufacture-and-trade-july-2016>.

Temblores, Indepaz, and PAIS, “Informe de Temblores, Indepaz y Pais a la CIDH sobre las violaciones a los derechos humanos cometidas por la fuerza pública contra la población civil colombiana en el marco del Paro”, (June 2021), accessible at: <http://www.derechos.org/nizkor/////colombia/doc/duque54.html#disparos>.

*Tirado v City of Minneapolis*, 521 F. Supp. 3d 833 (D. Minn. 2021), accessible at: <https://www.documentcloud.org/documents/20491477-2021-02-22-memorandum-opinion>.

United Nations Code of Conduct for Law Enforcement Officials, adopted by General Assembly resolution 34/169 of 17 December 1979 available at: <https://www.ohchr.org/en/professionalinterest/pages/lawenforcementofficials.aspx#:~:text=Law%20enforcement%20officials%20shall%20at,responsibility%20required%20by%20their%20profession.>

UNHRC Res. 25/38 (2014).

UNHRC Res. 38/11 (2018).

## Section 4: New and revised recommendations and the way forward

African Commission, 472 Resolution on the prohibition of the use, production, export and trade of tools used for torture. ACHPR/Res.472 (LXVII) 2020, accessible at: <https://www.achpr.org/sessions/resolutions?id=497>.

Amnesty International, “Blunt force: Investigating the misuse of police batons and related equipment, accessible at: <https://www.amnesty.org/en/latest/research/2021/09/blunt-force/>.

United Nations Office of the High Commissioner for Human Rights, Guiding Principles on Business and Human Rights: Implementing the United Nations ‘Protect, Respect and Remedy’ Framework, (2011), accessible at: [https://www.ohchr.org/documents/publications/guidingprinciplesbusinesshr\\_en.pdf](https://www.ohchr.org/documents/publications/guidingprinciplesbusinesshr_en.pdf).

ENDS.



